



Title	<i>Reference Design Report for a Low-Power, Low-Cost 180 W PFC Front End Using HiperPFS™ PFS708EG</i>
Specification	90 VAC – 264 VAC Input; 380 VDC Output
Application	PFC Front End
Author	Applications Engineering Department
Document Number	RDR-248
Date	March 25, 2011
Revision	1.0

Summary and Features

- Low component count, low-cost, low-power PFC
- EN61000-3-2 Class-D compliance
- High PFC efficiency enables 80+ PC Main design
- Frequency sliding maintains high efficiency across load range
- Feed forward line sense gain – maintains relatively constant loop gain over entire operating voltage range
- Excellent transient load response
- Power Integration eSIP low-profile controller package
- Integrated +15 VDC auxiliary power supply on board

PATENT INFORMATION

The products and applications illustrated herein (including transformer construction and circuits external to the products) may be covered by one or more U.S. and foreign patents, or potentially by pending U.S. and foreign patent applications assigned to Power Integrations. A complete list of Power Integrations' patents may be found at www.powerint.com. Power Integrations grants its customers a license under certain patent rights as set forth at <http://www.powerint.com/ip.htm>.

Table of Contents

1	Introduction.....	5
2	Design Goals.....	5
3	Power Supply Specification.....	7
4	Schematic.....	8
5	Circuit Description.....	9
5.1	Input EMI Filter and Rectifier.....	9
5.2	PFS708EG Boost Converter.....	9
5.3	Input Feed Forward Sense Circuit.....	10
5.4	Output Feedback.....	10
5.5	Bias Supply.....	10
5.5.1	Input EMI Filtering.....	10
5.5.2	TNY274GN Primary.....	10
5.5.3	Output Rectification.....	11
5.5.4	Output Feedback.....	11
5.5.5	Overshoot Shutdown.....	11
5.5.6	Design Aspects for EMI.....	11
5.5.7	Undervoltage Lockout.....	11
5.6	Bias Supply Series Regulator.....	12
6	PCB Layout.....	13
7	Bill of Materials.....	14
8	Transformer Design Spreadsheet (T2).....	17
9	Inductor Design Spreadsheet (L5).....	20
10	Auxiliary Supply Transformer Specification.....	23
10.1	Electrical Diagram.....	23
10.2	Electrical Specifications.....	23
10.3	Materials.....	23
10.4	Transformer Build Diagram.....	24
10.5	Transformer Construction.....	24
10.6	Transformer Illustrations.....	25
11	Switching Inductor Specification.....	28
11.1	Electrical Diagram.....	28
11.2	Electrical Specifications.....	28
11.3	Materials.....	28
11.4	Inductor Winding Instruction.....	29
12	EMI Differential Inductor Specification.....	32
12.1	Electrical Diagram.....	32
12.2	Electrical Specifications.....	32
12.3	Materials.....	32
12.4	Inductor Winding Instruction.....	33
12.5	Inductance Value and Mounting.....	34
13	Heat Sink Specification.....	35
13.1	eSIP U1 Heat Sink.....	35
13.2	eSIP U1 Heat Sink Assembly.....	36
13.3	eSIP U1 Heat Sink Assembly and Mounting Hardware.....	37



13.4	Bridge BR1 Heat Sink.....	38
13.5	Bridge BR1 Heat Sink Assembly	39
13.6	Bridge BR1 Heat Sink Assembly and Mounting Hardware Assembly.....	40
14	Performance Data	41
14.1	Auxiliary Supply Efficiency (with PFC disabled).....	41
14.2	Auxiliary Supply Load Regulation (with PFC disabled).....	42
14.3	Auxiliary Supply Line Regulation (with PFC disabled)	43
14.4	No-Load Input Power	44
14.5	PFC Efficiency (with RT1 in-circuit)	45
14.6	Input Power Factor	46
14.7	Regulation	47
14.7.1	Load	47
14.7.2	Line.....	48
14.7.3	Overload.....	49
14.8	THDi	50
14.9	Input Current Harmonic Distortion (IEC 61000-3-2 Class-D).....	51
14.9.1	50% Load at Output.....	51
14.9.2	100% Load at Output.....	52
15	Thermal Performance.....	53
16	Waveforms	55
16.1	Auxiliary +15 V Supply.....	55
16.1.1	Load Transient Response	55
16.2	Input Current at 115 VAC and 60 Hz	56
16.3	Input Current at 230 VAC and 50 Hz	56
16.4	Start-up at 90 VAC and 60 Hz	57
16.5	Start-up at 115 VAC and 60 Hz	57
16.6	Start-up at 230 VAC and 50 Hz	58
16.7	Start-up at 264 VAC and 50 Hz	58
16.8	Load Transient Response (90 VAC, 60 Hz).....	59
16.9	Load Transient Response (115 VAC, 60 Hz).....	60
16.10	Load Transient Response (230 VAC, 50 Hz)	60
16.11	Load Transient Response (264 VAC, 50 Hz)	61
16.12	1000 ms Line Dropout (115 VAC / 60 Hz and 230 VAC / 50 Hz)	61
16.12.1	50% Load at Output	61
16.12.2	Full Load at Output	62
16.13	One Cycle Line Dropout (115 VAC / 60 Hz and 230 VAC / 50 Hz)	62
16.13.1	Full Load at Output	62
16.14	Line Sag (115 VAC ~ 85 VAC ~ 115 VAC, 60 Hz)	63
16.15	Line Surge (132 VAC ~ 147 VAC ~ 132 VAC, 60 Hz)	63
16.16	Line Sag (230 VAC ~ 170 VAC ~ 230 VAC, 50 Hz)	64
16.17	Line Surge (264 VAC ~ 293 VAC ~ 264 VAC, 50 Hz)	64
16.18	Brown-In and Brown-Out at 6 V / Minute Rate	65
16.19	Drain Voltage and Current	66
16.19.1	Drain Voltage and Current at 115 VAC Input and Full Load.....	66
16.19.2	Drain Voltage and Current at 230 VAC Input and Full Load.....	67
16.20	Output Ripple Measurements	68



16.20.1	Ripple Measurement Technique	68
16.20.2	Measurement Results	69
17	Gain-Phase Measurement Procedure and Results	71
18	Line Surge Test.....	73
19	EMI Scans.....	74
19.1	EMI Test Set-up	74
19.2	EMI Scans	75
20	Appendix A - Test Set-up for Efficiency Measurement.....	77
21	Appendix B - Inductor Current Measurement Set-up	78
22	Revision History	80

Important Note:

All testing should be performed using an isolation transformer to provide the AC input to the prototype board.



1 Introduction

This document is an engineering report describing a PFC power supply utilizing a HiperPFS PFS708EG integrated PFC controller. This power supply is intended as a general purpose evaluation platform that operates from universal input line power and provides a regulated 380 V DC output voltage and a continuous output power of 180 W.

This power supply can deliver rated power at 115 VAC source voltage or higher at ambient temperature of 25 °C. For operation at higher temperatures or lower input voltages, use of forced air cooling is recommended.

The document contains the power supply specification, schematic, bill of materials, inductor documentation, printed circuit layout, and performance data.

2 Design Goals

To meet the goal of low solution cost the following considerations were made:

- Low cost Sendust core for boost inductor
- Single strand wire used for boost inductor (vs. more expensive Litz)
- Surface mount boost diode to eliminate heat sink
- Standard ultrafast diode

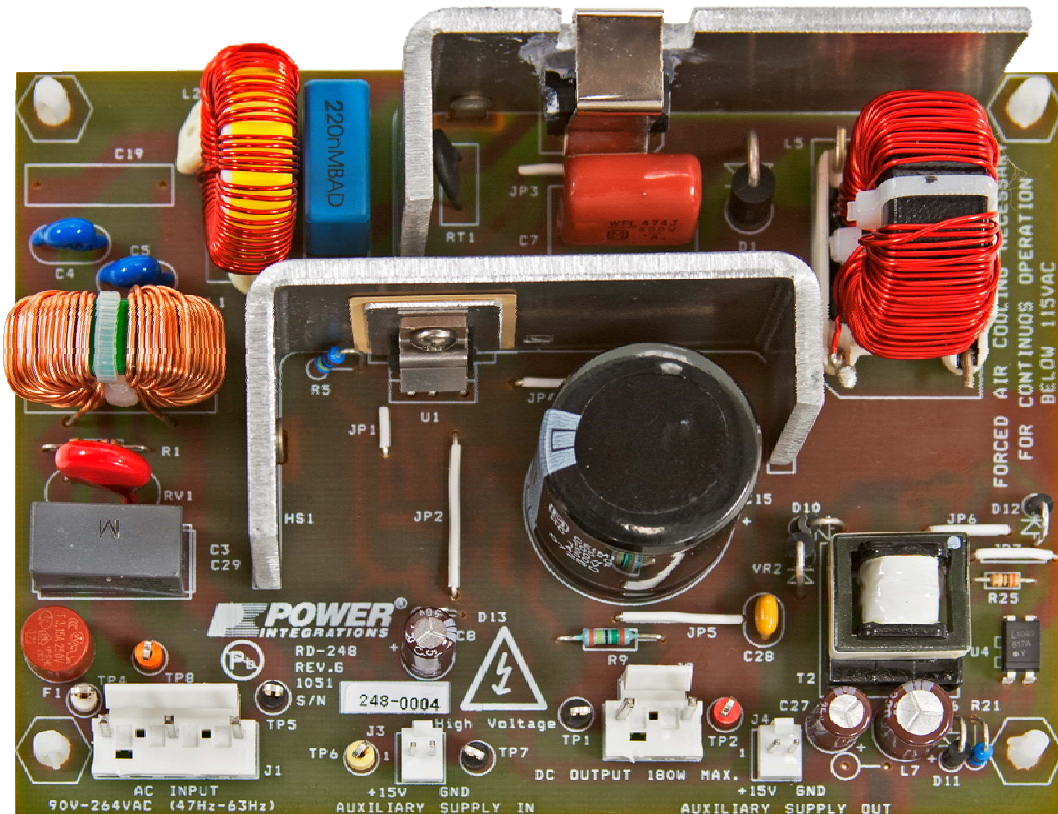

Figure 1 – Populated Circuit Board Photograph (Top).



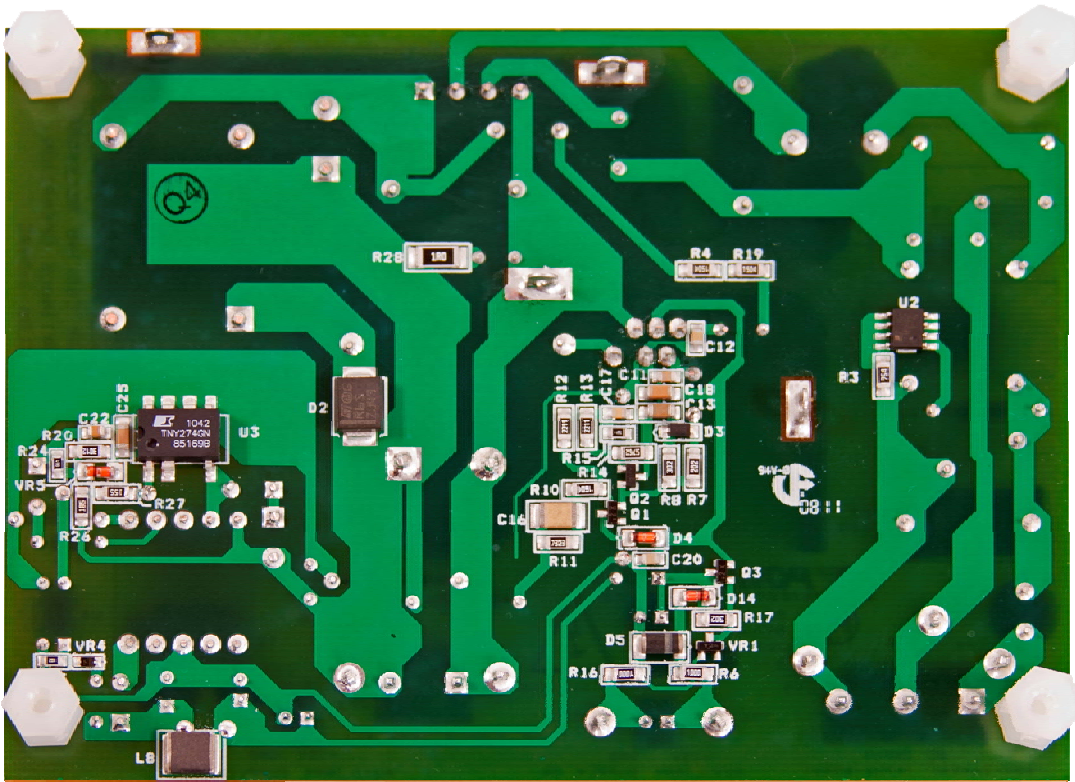

Figure 2 – Populated Circuit Board Photograph (Bottom).



3 Power Supply Specification

The table below represents the minimum acceptable performance of the design. Actual performance is listed in the results section.

Description	Symbol	Min	Typ	Max	Units	Comment
Input						
Voltage	V_{IN}	90		264	VAC	3 Wire
Frequency	f_{LINE}	47	50/60	64	Hz	
Output						
Output Voltage	V_{OUT}	370	380	390	V	20 MHz bandwidth
Output Ripple Voltage p-p	V_{RIPPLE}			30	V	
Output Current	I_{OUT}		0.474		A	
Total Output Power						
Continuous Output Power	P_{OUT}		180		W	
Efficiency						
Full Load	η	94			%	Measured at P_{OUT} 25 °C
Minimum efficiency at 20, 50 and 100 % of P_{OUT}	η_{80+}	94			%	Measured at 115 VAC Input
Environmental						
Line Surge						1.2/50 μ s surge, IEC 1000-4-5, Series Impedance: Differential Mode: 2 Ω Common Mode: 12 Ω
Differential Mode (L1-L2)			1		kV	
Common mode (L1/L2-PE)			2		kV	
Ambient Temperature	T_{AMB}	0		50	°C	Forced convection required at T_{AMB} > 25 °C and/or V_{IN} < 115 V, sea level
Auxiliary Supply Output						
Auxiliary Supply output voltage	V_{AUX}	14.5	15.0	16.5	V	DC Supply Output Voltage DC Supply Output Current
Auxiliary Supply output current	I_{AUX}			0.2	A	
Auxiliary Supply Input						
Auxiliary Supply	V_{AUX}	15		24	V	DC Supply



5 Circuit Description

This PFC is designed around the Power Integrations PFS708EG integrated PFC controller. This design is rated for a continuous output power of 180 W and provides a regulated output voltage of 380 VDC nominal, maintaining a high input power factor and overall efficiency over line and load, while minimizing overall solution in cost.

5.1 Input EMI Filter and Rectifier

Fuse F1 provides over-current protection to the circuit and isolates it from the AC supply in the event of a fault. Diode Bridge BR1 rectifies the AC input. Capacitors C3, C4, C5 and C6 in conjunction with inductors L1 and L2, constitute the EMI filter for attenuating both common mode and differential mode conducted noise. Film capacitor C7 provides input decoupling charge storage to reduce input ripple current at the switching frequency and its harmonics.

Resistors R1, R3 and CAPZero IC U2 are provided to discharge the EMI filter capacitors after line voltage has been removed from the circuit, while dissipating zero power during operation. CAPZero eliminates the losses from R1 and R3 by acting as a switch that only closes when the AC input is removed.

Metal Oxide Varistor (MOV) RV1 protects the circuit during line surge events by effectively clamping the input voltage seen by the power supply.

5.2 PFS708EG Boost Converter

The boost converter stage consists of inductor L5, ultrafast rectifier D2 and the PFS708EG IC U1. This converter stage operates as a boost converter, thereby maintaining a sinusoidal input current to the power supply while regulating the output DC voltage.

During start-up, diode D1 provides an inrush current path to the output capacitor C15 which bypasses the switching inductor L5 and switch U1. This prevents a resonant interaction between the switching inductor and output capacitor which results in a higher drain voltage on U1 and potential saturation of the boost inductor.

NTC Thermistor RT1 limits inrush current of the supply when line power is first applied. For improved efficiency operation, RT1 may be bypassed by a mechanical relay after power-on, or may be replaced with a fixed resistor and a FET which bypasses the resistor after the inrush transient.

Capacitor C14 provides a short, high-frequency return path to RTN for improved EMI results and to reduce U1 MOSFET peak drain voltage overshoot after turn-off. Resistor R28 provides damping for this return path to minimize ringing. Capacitor C18 and C20 decouple and bypass the U1 VCC pin.



5.3 Input Feed Forward Sense Circuit

The input voltage of the power supply is sensed by the IC U1 using resistors R4, R5 and R19. The capacitor C12 bypasses the V pin on IC U1.

5.4 Output Feedback

An output voltage resistive divider network consisting of resistors R9, R10, R11 and R14 provide a scaled voltage proportional to the output voltage as feedback to the controller IC U1. The circuit consisting of diode D4, transistors Q1, Q2, resistors R12 and R13 and capacitor C16 form a non-linear feedback circuit which improves the transient response of the PFC circuit.

Resistor R15 and capacitor C13 provide the control loop dominant pole. Capacitor C17, C11 and R7 attenuate high-frequency noise.

The resistor R8 in series with capacitor C13 provides a low frequency compensation zero while diode D3 protects against errant operation caused by an accidentally shorted C13. If capacitor C13 is accidentally shorted, diode D3 ensures that the voltage at the FB pin of IC U1 is below the FB_OFF threshold preventing operation of the IC.

5.5 Bias Supply

Integrated into the PFC design is a +15 V, 3.0 W auxiliary flyback power supply utilizing the TNY274GN. Secondary side constant voltage (CV) is accomplished through optocoupler feedback with a Zener reference.

5.5.1 Input EMI Filtering

The PFC output is further filtered and decoupled by the bulk storage capacitor C28.

5.5.2 TNY274GN Primary

The IC U3 integrates a power MOSFET, oscillator, control, start-up, and protection functions of the auxiliary supply.

The high-voltage input is applied to the primary winding of transformer T2. The other end of the transformer primary is connected to the Drain terminal of IC U3. Diodes D10 and VR2 form the primary clamp network which limits the peak drain voltage resulting from leakage inductance of transformer T2 primary winding. The selection of a slow diode for D10 improves conducted EMI but should be a glass passivated type, with a recovery time of $\leq 4 \mu\text{s}$.

IC U3 employs ON/OFF control to regulate the output in response to the feedback signal present on the EN/UV pin. During normal operation, switching of the power MOSFET is disabled when a current greater than 90 μA is sourced from the EN/UV pin. Currents below this threshold enable a switching cycle, which is terminated when the peak primary current reaches the internal current limit. An internal state machine sets the current limit to one of 4 levels appropriate for the operating conditions, ensuring that the switching frequency remains above the audible range until the transformer flux density drops to a



level below that which can create audible noise. This practically eliminates audible noise when standard dip varnishing of the transformer is employed.

Capacitor C25 is a 0.1 μ F BP/M pin bypass capacitor.

5.5.3 Output Rectification

Output rectification is provided by diode D11. A low-ESR capacitor C26 achieves minimum output voltage ripple.

5.5.4 Output Feedback

Output voltage is regulated by the Zener diode VR4. When the output exceeds the Zener threshold, current will flow in the optocoupler LED which will result in the photo-transistor of the optocoupler U4 to conduct, thereby inhibiting the next switching cycle by sinking sufficient current from the enable pin of IC U3. When the voltage reduces, the photo-transistor current reduces, allowing a switching cycle to occur when current from the ENABLE pin falls below the enable threshold. Output regulation is maintained via this cycle-by-cycle on-off control.

5.5.5 Overvoltage Shutdown

Overvoltage detection is accomplished by sensing the voltage at the output of the bias winding. The overvoltage threshold is the sum of VR5 and the BYPASS pin voltage (28 V + 5.8 V). When an overvoltage condition occurs such that the bias winding output voltage exceeds the overvoltage threshold, current begins to flow into the BYPASS pin of U3. When this current exceeds 5 mA, the internal shutdown circuit in the TinySwitch-III IC is activated. The IC is reset by removing input power allowing the BYPASS pin voltage to drop below 2 V.

5.5.6 Design Aspects for EMI

The switching frequency jitter feature of TNY274GN provides excellent conducted and radiated EMI performance for the auxiliary supply circuitry.

5.5.7 Undervoltage Lockout

Resistors R26 and R27 constitute an undervoltage UV detect resistor. The line UV detect feature of the TinySwitch-III senses the current flowing in EN/UV pin to determine the line voltage at which to start switching. In addition, this UV detect feature, prevents the power supply from attempting to restart once output regulation is lost, unless the input voltage is above the start-up threshold. The R26 and R27 combined value of 3.3 M Ω shown in Figure 3 will set the auxiliary supply start-up threshold to approximately 90 VDC (65 VAC).

The output of the auxiliary supply is available on an output power connector for use in powering supervisory or other auxiliary house keeping circuits.



5.6 Bias Supply Series Regulator

The PFS708EG IC requires a regulated V_{CC} supply of 12 V for operation, with an absolute maximum voltage rating of 13.4 V. V_{CC} levels in excess of this maximum could result in failure of U1. Resistor R17, Zener diode VR1, and transistor Q3 form a shunt regulator that prevents the supply voltage to IC U1 from exceeding 12 V. Capacitors C8 and C20 filter the input and series regulated supply voltage to ensure reliable operation of IC U1.

Resistors R6, R16 provide filtering of an alternate external voltage source and provide reverse polarity protection in conjunction with diode D5.

Diodes D13 and D14 provide diode ORing, allowing U1 to be powered either from the on-board +15 V auxiliary flyback supply or from an external voltage source.

The on-board +15 V auxiliary supply is made available on J4 to power external housekeeping circuitry.



6 PCB Layout

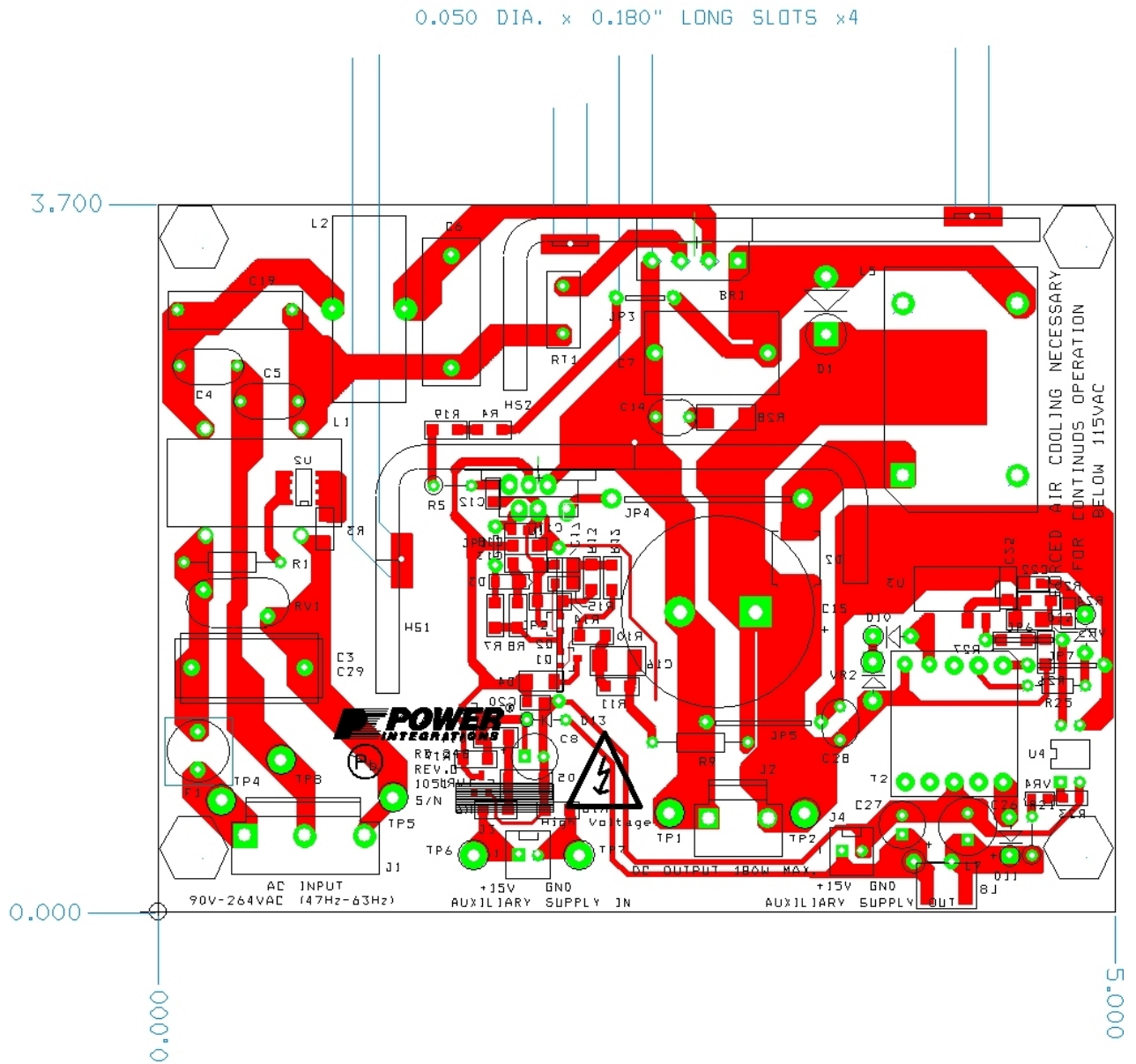

Figure 5 – Printed Circuit Layout.



7 Bill of Materials

Item	Qty	Ref Des	Description	Mfg Part Number	Mfg
1	1	BR1	600 V, 3 A, Bridge Rectifier	3KBP06M-E4/51	Vishay
2	1	C29	330 nF, 275 VAC, Film, X2	R46KI333000N1M	Kemet
3	2	C4 C5	150 pF, 250 VAC, Thru Hole, Ceramic Y-Capacitor	WKO151MCPCF0KR	Vishay / Roederstein
4	1	C6	220 nF, 275 VAC, Film, X2	PHE840MB6220MB12R17	Kemet
5	1	C7	470 nF, 400 V, Polypropylene Film	ECW-F4474JL	Panasonic
6	1	C8	47 μ F, 50 V, Electrolytic, Gen. Purpose, (6.3 x 11)	EKMG500ELL470MF11D	Nippon Chemi-Con
7	1	C11	10 nF, 50 V, Ceramic, X7R, 0805	ECJ-2VB1H103K	Panasonic
8	2	C12 C20	100 nF, 50 V, Ceramic, X7R, 0805	CC0805KRX7R9BB104	Yageo
9	1	C13	4.7 μ F, 25 V, Ceramic, X7R, 1206	ECJ-3YB1E475M	Panasonic
10	2	C14 C28	10 nF, 1 kV, Disc Ceramic, X7R	SV01AC103KAR	AVX
11	1	C15	150 μ F, 450 V, Electrolytic, (25 x 30)	EET-HC2W151CA	Panasonic
12	1	C16	100 nF, 200 V, Ceramic, X7R, 1812	18122C104KAT2A	AVX
13	1	C17	470 pF, 100 V, Ceramic, X7R, 0805	08051C471KAT2A	AVX
14	1	C18	1 μ F, 25 V, Ceramic, X7R, 1206	C3216X7R1E105K	TDK
15	1	C22	1 μ F, 50 V, Ceramic, X7R, 0805	08055D105KAT2A	AVX
16	1	C25	100 nF, 50 V, Ceramic, X7R, 1206	GRM319R71H104KA01D	Murata
17	1	C26	220 μ F, 25 V, Electrolytic, Very Low ESR, 72 m Ω , (8 x 11.5)	EKZE250ELL221MHB5D	Nippon Chemi-Con
18	1	C27	100 μ F, 25 V, Electrolytic, Gen. Purpose, (6.3 x 11)	EKMG250ELL101MF11D	Nippon Chemi-Con
19	1	D1	1000 V, 3 A, Rectifier, DO-201AD	1N5408-T	Diodes, Inc.
20	1	D2	600 V, 3 A, SMC, DO-214AB	STTH3R06S	ST Micro
21	1	D3	130 V, 5%, 250 mW, SOD-123	BAV116W-7-F	Diodes, Inc.
22	2	D4 D14	75 V, 0.15 A, Fast Switching, 4 ns, MELF	LL4148-13	Diodes, Inc.
23	1	D5	50 V, 1 A, Rectifier, Glass Passivated, DO-213AA (MELF)	DL4001-13-F	Diodes, Inc.
24	1	D10	600 V, 1 A, Fast Recovery Diode, 200 ns, DO-41	1N4937RLG	On Semi
25	1	D11	100 V, 1 A, Ultrafast Recovery, 35 ns, DO-41	MUR110RLG	On Semi
26	1	D12	150 V, 1 A, Ultrafast Recovery, 50 ns, DO-41	MUR115G	On Semi
27	1	D13	75 V, 300 mA, Fast Switching, DO-35	1N4148TR	Vishay
28	1	ESIPCLIP M4 METAL1	Heat sink Hardware, Edge Clip, 20.76 mm L x 8 mm W x 0.015 mm Thk	NP975864	Aavid Thermalloy
29	1	F1	3.15 A, 250V, Slow, TR5	37213150411	Wickman
30	1	HS1	U-shaped, e-SIP Heat sink w/ mounting brackets;	PI P/N: 76-00006-05	Power Integrations
31	1	HS2	L-shaped, diode bridge Heat sink w/ mounting brackets;	PI P/N: 76-00007-04	Power Integrations
32	1	HSPREADER ESIPPFISW1	Heat Spreader, Custom, Al, 3003, 0.030" Thk	61-00040-00	Custom
33	1	J1	5 Position (1x5) header, 0.156 pitch, Vertical	26-64-4050	Molex
34	1	J2	CONN HEADER 3 po (1x3).156 Vertical TIN	26-64-4030	Molex
35	2	J3 J4	2 Position (1x2) header, 0.1 pitch, Vertical	22-23-2021	Molex
36	1	JP1	Wire Jumper, [high-temp. e.g. Teflon] Insulated, #22 AWG, 0.2 in	2855/1 WH005	AlphaWire
37	1	JP2	Wire Jumper, [high-temp. e.g. Teflon] Insulated, #22 AWG, 0.8 in	2855/1 WH005	AlphaWire
38	1	JP3	Wire Jumper, [high-temp. e.g. Teflon] Insulated, #22 AWG, 0.3 in	2855/1 WH005	AlphaWire
39	1	JP4	Wire Jumper, [high-temp. e.g. Teflon] Insulated, #18 AWG, 1.0 in	2857/1 WH005	AlphaWire
40	1	JP5	Wire Jumper, [high-temp. e.g. Teflon] Insulated, #22 AWG, 0.6 in	2855/1 WH005	AlphaWire
41	2	JP6 JP7	Wire Jumper, [high-temp. e.g. Teflon] Insulated, #22 AWG, 0.4 in	2855/1 WH005	AlphaWire



Item	Qty	Ref Des	Description	Mfg Part Number	Mfg
42	1	L1	Common Mode Choke Toroidal	T22148-902S	Fontaine Tech
43	1	L2	Custom, 330 μ H constructed on Micrometals T94-26 toroidal core	SNX-R1575	Santronics
44	1	L5	Custom, 180 W PFC Inductor, 1.80 mH, constructed on Lodestone Pacific base PN VTM120-4	SNX-R1563	Santronics
45	1	L8	Ferrite Bead, 250 Ω , 4A, 2220 SMD	HI2220P251R-10	Laird-Signal Integrity Products
46	1	NUT1	Nut, Hex 4-40, SS		
47	4	POST-CRKT_BRD_6-32_HEX1 POST-CRKT_BRD_6-32_HEX2 POST-CRKT_BRD_6-32_HEX3 POST-CRKT_BRD_6-32_HEX4	Post, Circuit Board, Female, Hex, 6-32, snap, 0.375L, Nylon	561-0375A	Eagle Hardware
48	1	POWERCLIP1	Heat sink Hardware, Edge Clip 34N (7.6 lbs) 14.6 mm L x 10 mm W x 0.6 mm H	CLP212TG	Aavid Thermalloy
49	2	Q1 Q3	NPN, Small Signal BJT, GP SS, 40 V, 0.6 A, SOT-23	MMBT4401-TP	Micro Commercial
50	1	Q2	PNP, Small Signal BJT, 40 V, 0.6 A, SOT-23	MMBT4403-7-F	Diodes, Inc.
51	1	R1	750 k Ω , 5%, 1/4 W, Carbon Film	CFR-25JB-750K	Yageo
52	1	R3	750 k Ω , 5%, 1/4 W, Thick Film, 1206	ERJ-8GEYJ754V	Panasonic
53	2	R4 R19	1.50 M Ω , 1%, 1/4 W, Thick Film, 1206	ERJ-8ENF1504V	Panasonic
54	1	R5	1 M Ω , 1%, 1/4 W, Metal Film	MFR-25FBF-1M00	Yageo
55	2	R6 R16	100 Ω , 1%, 1/4 W, Thick Film, 1206	ERJ-8ENF1000V	Panasonic
56	1	R7	2 k Ω , 5%, 1/4 W, Thick Film, 1206	ERJ-8GEYJ202V	Panasonic
57	2	R8 R17	3 k Ω , 5%, 1/4 W, Thick Film, 1206	ERJ-8GEYJ302V	Panasonic
58	1	R9	1.5 Ω M, 1%, 1/4 W, Metal Film	RNF14FTD1M50	Stackpole
59	1	R10	1.60 M Ω , 1%, 1/4 W, Thick Film, 1206	ERJ-8ENF1604V	Panasonic
60	1	R11	732 k Ω , 1%, 1/4 W, Thick Film, 1206	ERJ-8ENF7323V	Panasonic
61	2	R12 R13	2.21 k Ω , 1%, 1/4 W, Thick Film, 1206	ERJ-8ENF2211V	Panasonic
62	1	R14	57.6 k Ω , 1%, 1/4 W, Thick Film, 1206	ERJ-8ENF5762V	Panasonic
63	1	R15	160 k Ω , 5%, 1/8 W, Thick Film, 0805	ERJ-6GEYJ164V	Panasonic
64	1	R20	30.1 k Ω , 1%, 1/4 W, Thick Film, 1206	ERJ-8ENF3012V	Panasonic
65	1	R21	681 Ω , 1%, 1/4 W, Metal Film	MFR-25FBF-681R	Yageo
66	1	R23	1 k Ω , 5%, 1/8 W, Thick Film, 0805	ERJ-6GEYJ102V	Panasonic
67	1	R24	47 Ω , 5%, 1/8 W, Thick Film, 0805	ERJ-6GEYJ470V	Panasonic
68	1	R25	20 Ω , 5%, 1/8 W, Carbon Film	CFR-12JB-20R	Yageo
69	1	R26	1.8 M Ω , 5%, 1/4 W, Thick Film, 1206	ERJ-8GEYJ185V	Panasonic
70	1	R27	1.5 M Ω , 5%, 1/4 W, Thick Film, 1206	ERJ-8GEYJ155V	Panasonic
71	1	R28	1 Ω , 5%, 3/4 W, Thick Film, 2010	ERJ-12ZYJ1R0U	Panasonic
72	1	RT1	NTC Thermistor, 10 Ω , 3.2 A	CL-110	GE Sensing
73	1	RTV1	Thermally conductive Silicone Grease	120-SA	Wakefield
74	1	RV1	320 V, 23 J, 10 mm, RADIAL	V320LA10P	Littlefuse
75	1	SCREW1	SCREW MACHINE PHIL 4-40 X 3/8 SS	PMSSS 440 0038 PH	Building Fasteners
76	1	T2	Bobbin, EE16, Horizontal, 10 pins Transformer	PM-9820 [PI P/N: 25-00861-00] SNX-R1562	Ho Jinn Plastic Santronics
77	1	TO-220 PAD1	HEATPAD TO-247 .006" K10	K10-104	Bergquist
78	3	TP1 TP5 TP7	Test Point, BLK,THRU-HOLE MOUNT	5011	Keystone
79	1	TP2	Test Point, RED,THRU-HOLE MOUNT	5010	Keystone
80	1	TP4	Test Point, WHT,THRU-HOLE MOUNT	5012	Keystone
81	1	TP6	Test Point, YEL,THRU-HOLE MOUNT	5014	Keystone



Item	Qty	Ref Des	Description	Mfg Part Number	Mfg
82	1	TP8	Test Point, ORG, THRU-HOLE MOUNT	5013	Keystone
83	1	U1	HiperPFS, eSIP7/6-TH	PFS708EG	Power Integrations
84	1	U2	CAPZero, SO-8C	CAP002DG	Power Integrations
85	1	U3	TinySwitch-III, SMD-8C	TNY274GN	Power Integrations
86	1	U4	Optocoupler, 35 V, CTR 80-160%, 4-DIP	LTV-817A	Liteon
87	1	VR1	12 V, 5%, 225 mW, SOT23	BZX84C12LT1G	On Semi
88	1	VR2	200 V, 5 W, 5%, TVS, DO204AC (DO-15)	P6KE200ARLG	On Semi
89	1	VR4	13 V, 2%, 300 mW, SOD-323	BZX384-B13,115	NXP Semi
90	1	VR5	28 V, 5%, 500 mW, DO-213AA (MELF)	ZMM5255B-7	Diodes, Inc.
91	1	WASHER6	Washer, Shoulder, #4, 0.095 Shoulder x 0.117 Dia, Polyphenylene Sulfide PPS	7721-10PPSG	Aavid Thermalloy
92	1	WASHER7	Washer Teflon #6, ID 0.156, OD 0.312, Thk 0.031	FWF-6	Distributor
93	1	Label	"High Voltage" warning label, (eSIP Heat sink)	LPP0580	Image-Tek
94	1	Adhesive1	Hot-melt Adhesive	3748-VO-TC	3M



8 Transformer Design Spreadsheet (T2)

ACDC_TinySwitch-III_120209; Rev.1.26; Copyright Power Integrations 2008	INPUT	INFO	OUTPUT	UNIT	ACDC_TinySwitch-III_120209_Rev1-26.xls; TinySwitch-III Continuous/Discontinuous Flyback Transformer Design Spreadsheet
ENTER APPLICATION VARIABLES					
VACMIN	65			Volts	Minimum AC Input Voltage
VACMAX	290			Volts	Maximum AC Input Voltage
fL	50			Hertz	AC Mains Frequency
VO	15.00			Volts	Output Voltage (at continuous power)
IO	0.20			Amps	Power Supply Output Current (corresponding to peak power)
Power			3	Watts	Continuous Output Power
n	0.75				Efficiency Estimate at output terminals. Under 0.7 if no better data available
Z	0.50				Z Factor. Ratio of secondary side losses to the total losses in the power supply. Use 0.5 if no better data available
tC	0.75			mSeconds	Bridge Rectifier Conduction Time Estimate
CIN	120.00		120	uFarads	Input Capacitance
ENTER TinySwitch-III VARIABLES					
TinySwitch-III	Auto		TNY274G		Recommended TinySwitch-III
<i>Chosen Device</i>		<i>TNY274G</i>			
Chose Configuration	STD		Standard Current Limit		Enter "RED" for reduced current limit (sealed adapters), "STD" for standard current limit or "INC" for increased current limit (peak or higher power applications)
ILIMITMIN			0.233	Amps	Minimum Current Limit
ILIMITTYP			0.250	Amps	Typical Current Limit
ILIMITMAX			0.267	Amps	Maximum Current Limit
fSmin			124000	Hertz	Minimum Device Switching Frequency
I ² fmin			7.43	A ² kHz	I ² f (product of current limit squared and frequency is trimmed for tighter tolerance)
VOR	115.00		115	Volts	Reflected Output Voltage (VOR < 135 V Recommended)
VDS	11.30		11.3	Volts	TinySwitch-III on-state Drain to Source Voltage
VD	0.85		0.85	Volts	Output Winding Diode Forward Voltage Drop
KP			2.03		Ripple to Peak Current Ratio (KP < 6)
KP_TRANSIENT			1.72		Transient Ripple to Peak Current Ratio. Ensure KP_TRANSIENT > 0.25
ENTER BIAS WINDING VARIABLES					
VB	22		22.00	Volts	Bias Winding Voltage
VDB	0.95		0.95	Volts	Bias Winding Diode Forward Voltage Drop
NB			13.88		Bias Winding Number of Turns
VZOV	28		28.00	Volts	Over Voltage Protection zener diode voltage.
UVLO VARIABLES					
V_UV_TARGET	90		90.00	Volts	Target DC under-voltage threshold, above which the power supply will start
V_UV_ACTUAL			92.20	Volts	Typical DC start-up voltage based on standard value of RUV_ACTUAL
RUV_IDEAL			3.51	Mohms	Calculated value for UV Lockout resistor
RUV_ACTUAL			3.60	Mohms	Closest standard value of resistor to RUV_IDEAL
ENTER TRANSFORMER CORE/CONSTRUCTION VARIABLES					
Core Type	EE16		EE16		Enter Transformer Core
<i>Core</i>		<i>EE16</i>		<i>P/N:</i>	PC40EE16-Z
<i>Bobbin</i>		<i>EE16_BOBBIN</i>		<i>P/N:</i>	EE16_BOBBIN
AE			0.192	cm ²	Core Effective Cross Sectional Area
LE			3.5	cm	Core Effective Path Length
AL			1140	nH/T ²	Ungapped Core Effective Inductance



BW			8.6	mm	Bobbin Physical Winding Width
M	2.50		2.5	mm	Safety Margin Width (Half the Primary to Secondary Creepage Distance)
L	3.00		3		Number of Primary Layers
NS	10		10		Number of Secondary Turns
DC INPUT VOLTAGE PARAMETERS					
VMIN	87.00		87	Volts	Minimum DC Input Voltage
VMAX	410.00		410	Volts	Maximum DC Input Voltage
CURRENT WAVEFORM SHAPE PARAMETERS					
DMAX			0.39		Duty Ratio at full load, minimum primary inductance and minimum input voltage
IAVG			0.05	Amps	Average Primary Current
IP			0.2300	Amps	Minimum Peak Primary Current
IR			0.2300	Amps	Primary Ripple Current
IRMS			0.10	Amps	Primary RMS Current
TRANSFORMER PRIMARY DESIGN PARAMETERS					
LP			1037	uHenries	Typical Primary Inductance. +/- 10% to ensure a minimum primary inductance of 942 uH
LP_TOLERANCE	10.00		10	%	Primary inductance tolerance
NP			73		Primary Winding Number of Turns
ALG			197	nH/T ²	Gapped Core Effective Inductance
BM			1988	Gauss	Maximum Operating Flux Density, BM<3000 is recommended
BAC			994	Gauss	AC Flux Density for Core Loss Curves (0.5 X Peak to Peak)
ur			1654		Relative Permeability of Ungapped Core
LG			0.10	mm	Gap Length (Lg > 0.1 mm)
BWE			10.8	mm	Effective Bobbin Width
OD			0.150	mm	Maximum Primary Wire Diameter including insulation
INS			0.03	mm	Estimated Total Insulation Thickness (= 2 * film thickness)
DIA			0.110	mm	Bare conductor diameter
AWG			37	AWG	Primary Wire Gauge (Rounded to next smaller standard AWG value)
CM			20	Cmils	Bare conductor effective area in circular mils
CMA			208	Cmils/Amp	Primary Winding Current Capacity (200 < CMA < 500)
TRANSFORMER SECONDARY DESIGN PARAMETERS					
Lumped parameters					
ISP			1.69	Amps	Peak Secondary Current
ISRMS			0.61	Amps	Secondary RMS Current
IRIPPLE			0.58	Amps	Output Capacitor RMS Ripple Current
CMS			122	Cmils	Secondary Bare Conductor minimum circular mils
AWGS			29	AWG	Secondary Wire Gauge (Rounded up to next larger standard AWG value)
VOLTAGE STRESS PARAMETERS					
VDRAIN			672	Volts	Maximum Drain Voltage Estimate (Assumes 20% zener clamp tolerance and an additional 10% temperature tolerance)
PIVS			72	Volts	Output Rectifier Maximum Peak Inverse Voltage
TRANSFORMER SECONDARY DESIGN PARAMETERS (MULTIPLE OUTPUTS)					
1st output					
VO1			15	Volts	Main Output Voltage (if unused, defaults to single output design)
IO1			0.200	Amps	Output DC Current
PO1			3.00	Watts	Output Power
VD1			0.850	Volts	Output Diode Forward Voltage Drop
NS1			10.00		Output Winding Number of Turns
ISRMS1			0.611	Amps	Output Winding RMS Current
IRIPPLE1			0.58	Amps	Output Capacitor RMS Ripple Current
PIVS1			72	Volts	Output Rectifier Maximum Peak Inverse



					Voltage
Recommended Diodes			MUR110, UF4002, SB1100		Recommended Diodes for this output
CMS1			122	Cmils	Output Winding Bare Conductor minimum circular mils
AWGS1			29	AWG	Wire Gauge (Rounded up to next larger standard AWG value)
DIAS1			0.29	mm	Minimum Bare Conductor Diameter
ODS1			0.36	mm	Maximum Outside Diameter for Triple Insulated Wire
2nd output					
VO2				Volts	Output Voltage
IO2				Amps	Output DC Current
PO2			0.00	Watts	Output Power
VD2			0.7	Volts	Output Diode Forward Voltage Drop
NS2			0.44		Output Winding Number of Turns
SRMS2			0.000	Amps	Output Winding RMS Current
IRIPPLE2			0.00	Amps	Output Capacitor RMS Ripple Current
PIVS2			2	Volts	Output Rectifier Maximum Peak Inverse Voltage
Recommended Diode					Recommended Diodes for this output
CMS2			0	Cmils	Output Winding Bare Conductor minimum circular mils
AWGS2			N/A	AWG	Wire Gauge (Rounded up to next larger standard AWG value)
DIAS2			N/A	mm	Minimum Bare Conductor Diameter
ODS2			N/A	mm	Maximum Outside Diameter for Triple Insulated Wire
3rd output					
VO3				Volts	Output Voltage
IO3				Amps	Output DC Current
PO3			0.00	Watts	Output Power
VD3			0.7	Volts	Output Diode Forward Voltage Drop
NS3			0.44		Output Winding Number of Turns
SRMS3			0.000	Amps	Output Winding RMS Current
IRIPPLE3			0.00	Amps	Output Capacitor RMS Ripple Current
PIVS3			2	Volts	Output Rectifier Maximum Peak Inverse Voltage
Recommended Diode					Recommended Diodes for this output
CMS3			0	Cmils	Output Winding Bare Conductor minimum circular mils
AWGS3			N/A	AWG	Wire Gauge (Rounded up to next larger standard AWG value)
DIAS3			N/A	mm	Minimum Bare Conductor Diameter
ODS3			N/A	mm	Maximum Outside Diameter for Triple Insulated Wire
Total power			3	Watts	Total Output Power
Negative Output			N/A		If negative output exists enter Output number; eg: If VO2 is negative output, enter 2



9 Inductor Design Spreadsheet (L5)

ACDC_PFS_101210; Rev.1.0; Copyright Power Integrations 2010	INPUT	INFO	OUTPUT	UNITS	ACDC_HiperPFS_101210_Rev1-0.xls; Continuous Mode Boost Converter Design Spreadsheet
Enter Applications Variables					
Input Voltage Range	Universal		Universal		Select Universal or High_Line option
VACMIN			90	V	Minimum AC input voltage
VACMAX			265	V	Maximum AC input voltage
VBROWNNIN			77.76		Expected Minimum Brown-in Voltage
VBROWNOUT			70.40	V	Specify brownout voltage.
VO	385			V	Nominal Output voltage
PO	180			W	Nominal Output power
fL			50	Hz	Line frequency
TA Max			40	deg C	Maximum ambient temperature
n			0.93		Enter the efficiency estimate for the boost converter at VACMIN
KP	0.390		0.39		Ripple to peak inductor current ratio at the peak of VACMIN
VO_MIN			365.75	V	Minimum Output voltage
VO_RIPPLE_MAX			20	V	Maximum Output voltage ripple
tHOLDUP	16		16	ms	Holdup time
VHOLDUP_MIN			310	V	Minimum Voltage Output can drop to during holdup
I_INRUSH			40	A	Maximum allowable inrush current
Forced Air Cooling	Yes		Yes		Enter "Yes" for Forced air cooling. Otherwise enter "No"
PFS Parameters					
PFS Part Number	Auto		PFS708		Selected PFS device
IOCP min			5.50	A	Minimum Current limit
IOCP typ			6.10	A	Typical current limit
IOCP max			6.70	A	Maximum current limit
RDSON			0.73	ohms	Typical RDSon at 100 °C
RV			4.00	Mohms	Line sense resistor
C_VCC			1.00	uF	Supply decoupling capacitor
C_V			100.00	nF	V pin decoupling capacitor
C_FB			10.00	nF	Feedback pin decoupling capacitor
FS_PK			83.11	kHz	Estimated peak frequency of operation
FS_AVG			67.65	kHz	Estimated average frequency of operation
IP			3.77	A	MOSFET peak current
PFS_IRMS			2.04	A	PFS MOSFET RMS current
PCOND_LOSS_PFS			3.04	W	Estimated PFS conduction losses
PSW_LOSS_PFS			1.45	W	Estimated PFS switching losses
PFS_TOTAL			4.49	W	Total Estimated PFS losses
TJ Max			100	deg C	Maximum steady-state junction temperature
Rth-JS			3.00	degC/W	Maximum thermal resistance (Junction to heatsink)
HEATSINK Theta-CA			10.36	degC/W	Maximum thermal resistance of heatsink
Basic Inductor Calculation					
LPFC			626.17	uH	Value of PFC inductor at peak of VACMIN and Full Load
LPFC (0 Bias)			1797.35	uH	Value of PFC inductor at No load. This is the value measured with LCR meter
LPFC_RMS			2.42	A	Inductor RMS current (calculated at VACMIN and Full Load)
Inductor Construction Parameters					
Core Type	Sendust		Sendust		Enter "Sendust", "Pow Iron" or "Ferrite"
Core Material	90u		90u		Select from 60u, 75u, 90u or 125 u for Sendust cores. Fixed at PC44 or equivalent for Ferrite cores. Fixed at 52 material for Pow Iron cores.
Core Geometry	TOROID		TOROID		Select from Toroid or EE for Sendust cores and from EE, or PQ for Ferrite cores
Core	Auto		77589(OD=35.2)		Core part number
AE			45.4	mm^2	Core cross sectional area



LE			89.5	mm	Core mean path length
AL			57	nH/t^2	Core AL value
VE			4060	mm^3	Core volume
HT			9.78	mm	Core height/Height of window
MLT			38.4	cm	Mean length per turn
BW			N/A	mm	Bobbin width
NL			177		Inductor turns
LG			N/A	mm	Gap length (Ferrite cores only)
ILRMS			2.42	A	Inductor RMS current
Wire type	Regular				Select between "Litz" or "Regular" for double coated magnet wire
AWG	22	<i>Info</i>	22	AWG	!!! Info. Selected wire gauge is too too thick and may caused increased proximity losses. Select a thinner wire gauge
Filar	1		1		Inductor wire number of parallel strands
OD			0.643	mm	Outer diameter of single strand of wire
AC Resistance Ratio			3.08		Ratio of AC resistance to the DC resistance (using Dowell curves)
J			7.47	A/mm^2	Estimated current density of wires. It is recommended that $6 < J < 8$
BM_TARGET			N/A	Gauss	Target flux density at VACMIN (Ferrite cores only)
BM			2962	Gauss	Maximum operating flux density
BP			1840	Gauss	Peak Flux density (Estimated at VBROWNOUT)
LPFC_CORE_LOSS			1.27	W	Estimated Inductor core Loss
LPFC_COPPER_LOSS			2.43	W	Estimated Inductor copper losses
LPFC_TOTAL LOSS			3.70	W	Total estimated Inductor Losses
Critical Parameters					
IRMS			2.15	A	AC input RMS current
IO_AVG			0.47	A	Output average current
Output Diode					
Part Number	Auto		STTH3R06		PFC Diode Part Number
Type			ULTRAFAST		Diode Type - Special - Diodes specially catered for PFC applications, SiC - Silicon Carbide type, UF - Ultrafast recovery type
Manufacturer			ST		Diode Manufacturer
VRRM			600	V	Diode rated reverse voltage
IF			3	A	Diode rated forward current
TRR			70	ns	Diode Reverse recovery time
VF			1.1	V	Diode rated forward voltage drop
PCOND_DIODE			0.51	W	Estimated Diode conduction losses
PSW_DIODE			3.00	W	Estimated Diode switching losses
P_DIODE			3.52	W	Total estimated Diode losses
TJ Max			125	deg C	Maximum Operating temperature
Rth-JS			20.00	degC/W	Maximum thermal resistance (Junction to heatsink)
HEATSINK Theta-CA			3.67	degC/W	Maximum thermal resistance of heatsink
Output Capacitor					
CO	Auto		150.00	uF	Minimum value of Output capacitance
VO_RIPPLE_EXPECTED			10.7	V	Expected ripple voltage on Output with selected Output capacitor
T_HOLDUP_EXPECTED			19.7	ms	Expected holdup time with selected Output capacitor
ESR_LF			1.11	ohms	
ESR_HF			0.442	ohms	
IC_RMS_LF			0.33	A	Low Frequency Capacitor RMS current
IC_RMS_HF			0.95	A	High Frequency Capacitor RMS current
CO_LF_LOSS			0.12	W	Estimated Low Frequency ESR loss in Output capacitor
CO_HF_LOSS			0.40	W	Estimated High frequency ESR loss in Output capacitor
Total CO LOSS			0.52	W	Total estimated losses in Output Capacitor
Input Bridge and Fuse					
I^2t Rating			10.53	A^2s	Minimum I^2t rating for fuse



Fuse Current rating			3.27	A	Minimum Current rating of fuse
VF			0.90	V	Input bridge Diode forward Diode drop
I _{AVG}			2.03	A	Input average current at 70 VAC.
PIV_INPUT BRIDGE			375	V	Peak inverse voltage of input bridge
PCOND_LOSS_BRIDGE			3.49	W	Estimated Bridge Diode conduction loss
CIN			0	uF	Input capacitor. Use metallized polypropylene or film foil type with high ripple current rating
RT			8.42	ohms	Input Thermistor value
D_Precharge			1N5407		Recommended precharge Diode
Feedback Components					
R2			1.54	Mohms	Feedback network, first high voltage divider resistor
R3			1.54	Mohms	Feedback network, second high voltage divider resistor
R4			698.00	kohms	Feedback network, third high voltage divider resistor
C2			100.00	nF	Feedback network, loop speedup capacitor
R5			2.20	kohms	Feedback component, NPN transistor bias resistor
R6			2.20	kohms	Feedback component, PNP transistor bias resistor
R7			57.60	kohms	Feedback network, lower divider resistor
C3			470.00	pF	Feedback component- noise suppression capacitor
R8			160.00	kohms	Feedback network - pole setting resistor
R9			2.49	kohms	Feedback network - zero setting resistor
R10			10.00	kohms	Feedback pin filter resistor
C4			10.00	uF	Feedback network - compensation capacitor
D3			1N4148		Feedback network reverse blocking Diode
D4			1N4001		Feedback network - capacitor failure detection Diode
Q1			2N4401		Feedback network - speedup circuit NPN transistor
Q2			2N4403		Feedback network - speedup circuit PNP transistor
Loss Budget (Estimated at VACMIN)					
PFS Losses			4.49	W	Total estimated losses in PFS
Boost diode Losses			3.52	W	Total estimated losses in Output Diode
Input Bridge losses			3.49	W	Total estimated losses in input bridge module
Inductor losses			3.70	W	Total estimated losses in PFC choke
Output Capacitor Loss			0.52	W	Total estimated losses in Output capacitor
Total losses			15.71	W	Overall loss estimate
Efficiency			0.92		Estimated efficiency at VACMIN. Verify efficiency at other line voltages



10 Auxiliary Supply Transformer Specification

10.1 Electrical Diagram

3.0 W PFC V_{AUX} - Flyback-EE16

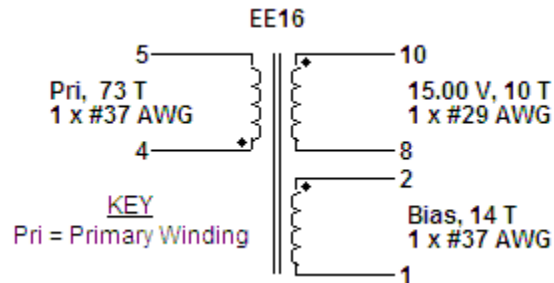

Figure 6 – Transformer Electrical Diagram.

10.2 Electrical Specifications

Electrical Strength	1 second, 60 Hz, from pins 1, 2, 4, 5 to pins 8, 10	3000 VAC
Primary Inductance	Pins 4-5, all other windings open, measured at 100 kHz, 1.0 Vpk-pk	1037 μ H \pm 10%
Resonant Frequency	Pins 4-5, all other windings open	1.1 MHz Min
Leakage Inductance	Pins 4-5, with secondary pins shorted, measured at 100 kHz, 1.0 Vpk-pk	41.5 μ H Max

10.3 Materials

Item	Description
[1]	Core: EE16, NC-2H (Nicera) or Equivalent, gapped for ALG of 197 nH/T ²
[2]	Bobbin: EE16, Horizontal, 10 pins, (5/5), Ho Jinn Plastic Elect. Co, Ltd. part #: PM-9820
[3]	Tape: Polyester web 2.50 mm wide
[4]	Barrier Tape: Polyester film (1 mil base thickness), 8.60 mm wide
[5]	Teflon Tubing # 22
[6]	Varnish
[7]	Magnet wire: #37 AWG, Solderable Double Coated
[8]	Magnet wire: #29 AWG, Solderable Double Coated

10.4 Transformer Build Diagram

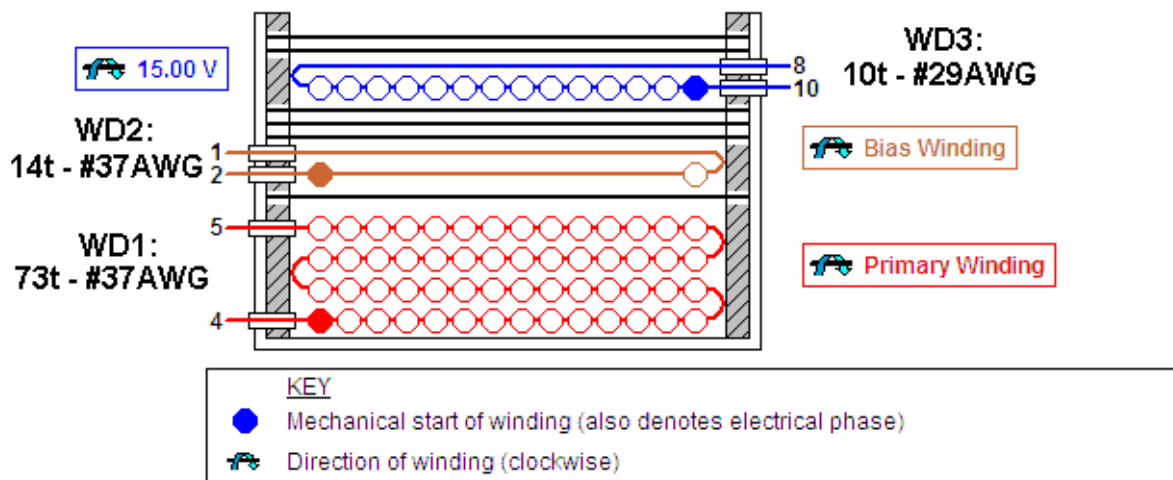

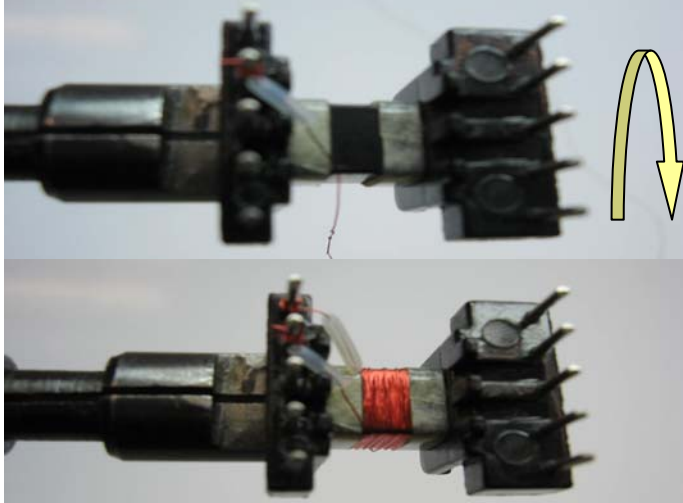
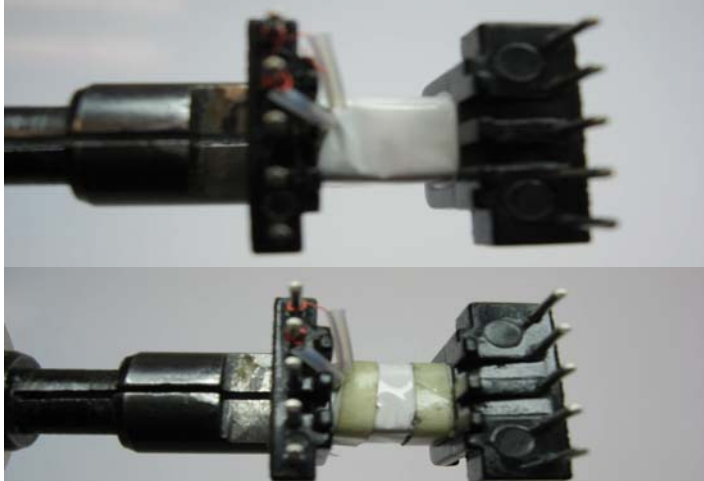

Figure 7 – Transformer Build Diagram.

10.5 Transformer Construction

Winding preparation	Position the bobbin on the mandrel such that the pin side is on the left side of bobbin mandrel. Winding direction is clock-wise direction
Left Margin Tape	Wind 2.5mm margin tape [Item 3] on left hand side of the bobbin
Right Margin Tape	Wind 2.5mm margin tape [Item 3] on right hand side of the bobbin
WD1 Primary	Start on pin(s) 4 using item [5] at the start leads and wind 73 turns (x 1 filar) of item [7] in 3 layer(s) from left to right. At the end of 1st layer, continue to wind the next layer from right to left. At the end of 2nd layer, continue to wind the next layer from left to right. On the final layer, spread the winding evenly across entire bobbin. Finish this winding on pin(s) 5 using item [5] at the finish leads.
Insulation	Add 1 layer of tape, item [4], for insulation.
WD2 Bias Winding	Start on pin(s) 2 using item [5] at the start leads and wind 14 turns (x 1 filar) of item [7]. Wind in same rotational direction as primary winding. Spread the winding evenly across entire bobbin. Finish this winding on pin(s) 1 using item [5] at the finish leads.
Insulation	Add 3 layers of tape, item [4], for insulation.
WD3 Secondary	Start on pin(s) 10 using item [5] at the start leads and wind 10 turns (x 1 filar) of item [8]. Spread the winding evenly across entire bobbin. Wind in same rotational direction as primary winding. Finish this winding on pin(s) 8 using item [5] at the finish leads.
Insulation	Add 2 layers of tape, item [4], for insulation.
Gap	Grind the cores to get 1037 μH,
Core Assembly	Assemble and secure core halves with tape. Item [1].
Varnish	Dip varnish uniformly in item [6]. Do not vacuum impregnate.



10.6 Transformer Illustrations

<p>Bobbin Preparation</p>		<p>One bobbin EE16 horizontal (5/5) and two core NC-2H or equivalent.</p>
<p>Winding Preparation</p>		<p>Position the bobbin on the mandrel as shown. Use 2.5 mm margin tape (item [3]) on the left-hand side. Use 2.5 mm margin tape (item [3]) on the right-hand side.</p>
<p>WD1 Primary</p>		<p>Starting at pin 4 using item [5] at the start leads, wind 73 turns of item [7] in four layers, with tight tension; wind first layer from left to right and at the end of the first layer, wind second layer from right to left, then left to right for third layer and right to left for fourth layer, terminating at pin 5 using item [5] at the finish leads.</p>
<p>Insulation and Margin Tape</p>		<p>Apply one layer of tape (item [4]) for insulation. Use 2.5 mm margin tape for both sides left and right.</p>



<p>WD2 Bias Winding</p>		<p>Starting at pin 2 using item [5] at start leads, wind 14 single-filar turns of item [7] in one layer. Bring the wire back to the left-hand side and terminate at pin 1, using item [5] at the finish leads.</p>
<p>Insulation. Tape and Margin.</p>		<p>Apply three layers of tape (item [4]). Use 2.5 mm margin for both sides left and right.</p>
<p>WD3 Secondary</p>		<p>Starting at pin 10 using item [5] at the start leads, wind 10 turns (x1 filar) of item [8] in one layer spreading the winding evenly across entire bobbin. Wind in the same rotational direction as primary winding. Terminate at pin 8 using item [5] at the finish leads.</p>



<p>Insulation</p>		<p>Apply two layers of tape (item [4]).</p>
<p>Finish Wrap</p>		<p>Apply three layers of tape for finish wrap.</p>
<p>Final Assembly</p>		<p>Assemble, grind the cores to get 1037 μH, and secure the cores with tape. Varnish item [6].</p>



11 Switching Inductor Specification

11.1 Electrical Diagram

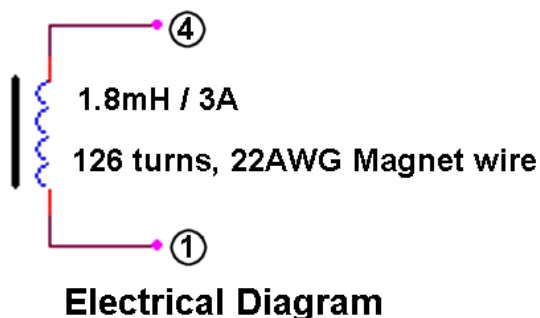

Figure 8 – Inductor Electrical Diagram.

11.2 Electrical Specifications

Primary Inductance	Pins 1-4 measured at kHz, 0.4 V RMS	1.8 mH ±8%
---------------------------	-------------------------------------	------------

11.3 Materials

Item	Description
[1]	Core: Selmag, Inc.: Sendust core: CS270090; Alternate: Magnetics Inc, Mfg: 77934-A7
[2]	Magnet wire: #22 AWG insulated magnet wire.
[3]	Base: Toroid mounting base, Lodestone Pacific, P/N VTM160-4, or similar. See below. PI P/N: 76-00004-00.
[4]	High Temperature Epoxy, Mfg: MG Chemicals, P/N: 832HT-375ML, Digikey: 473-1085-ND, or similar, PI P/N: 66-00087-00.
[5]	Divider: Tie-wrap, Panduit, P/N: PLT.7M-M or similar.

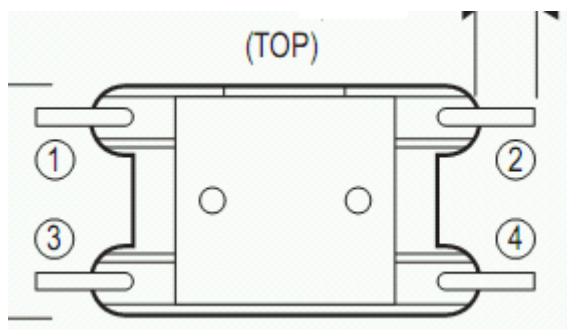
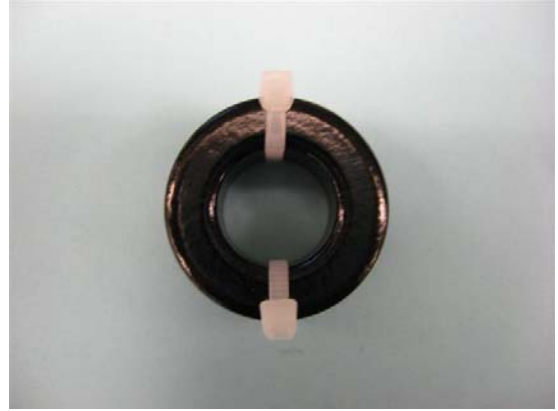
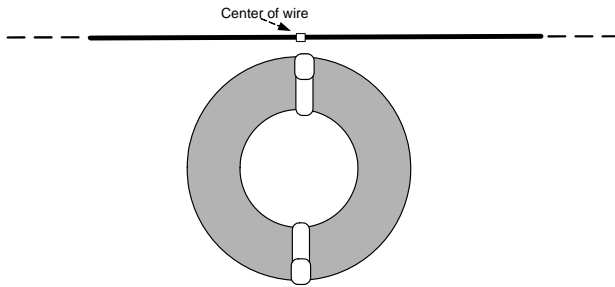

Figure 9 – Top View of Toroid Mounting Base Item [3].



11.4 Inductor Winding Instruction

- Insert 2 dividers item [5] in the core item [1] to divide into 2 sections equally. See photo. Superglue dividers in place if necessary to prevent slipping.
- Take approximately 17 feet of wire item [2], Align center of wire with 1 divider. This location on the inductor is your 'top' reference point.



- Start winding on the left section with approximately 24 turns of wire item [2], for the 1st layer, wind wire laminar fashion and ensure that turns do not overlap.

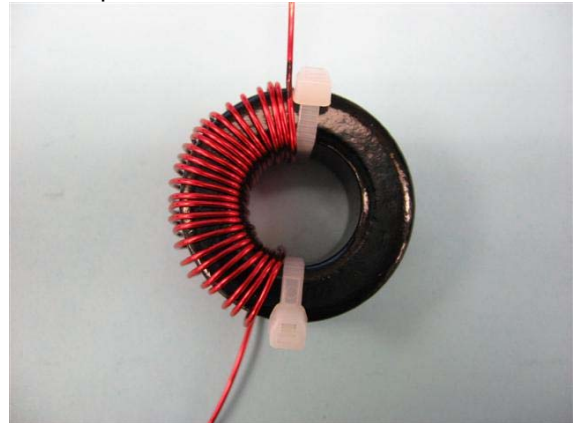
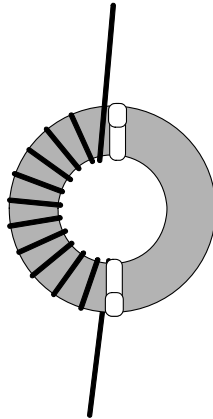

- Next, wind another 24 turns on the right hand side of the core.

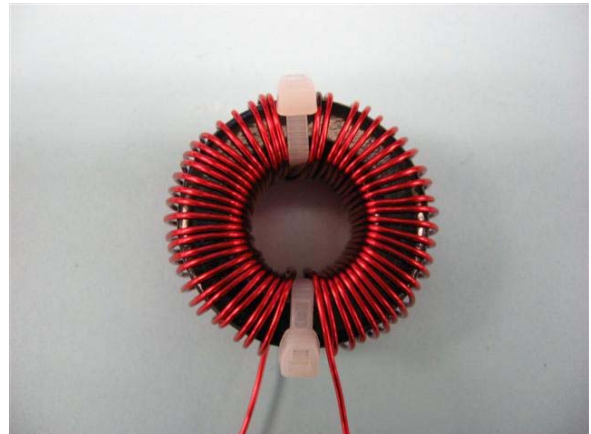
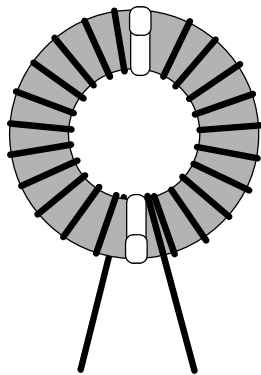

- Continue winding on the right hand side for the 2nd layer approximately 22 turns, spread wire evenly and try to ensure that turns do not overlap.

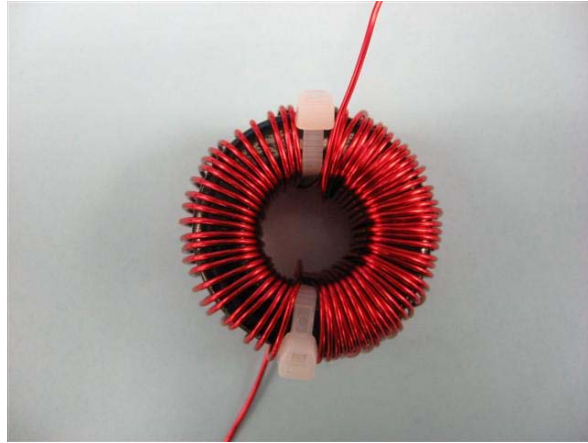
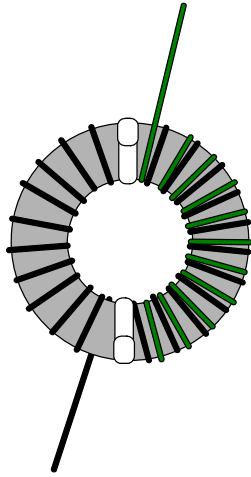

- Continue winding on the right section on the 3rd layer the remaining [approximately 17] turns, distributing wire evenly and try to ensure that turns do not overlap.

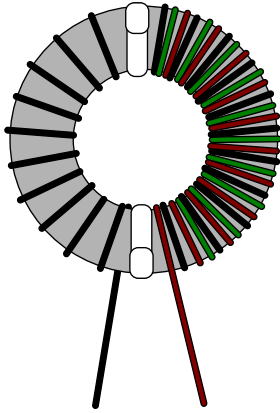

- Wind the same as above for the 2nd and 3rd layers on the left section. Inductor leads will finish at the 'bottom' of the inductor after all turns are wound.

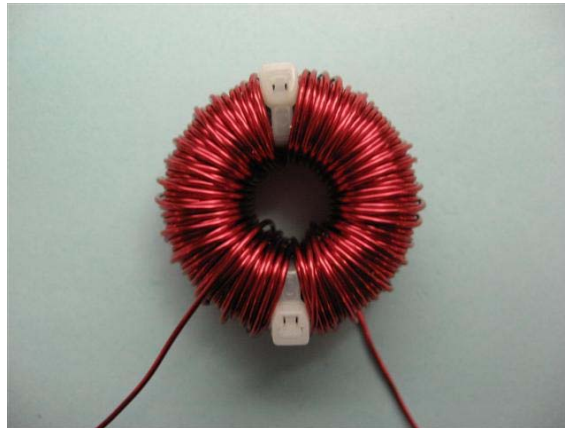
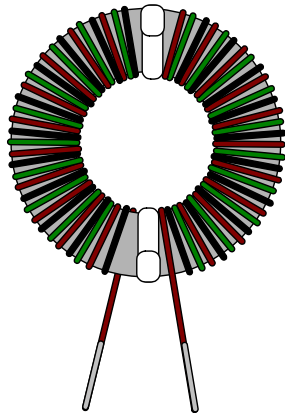

- Invert toroid with 'top' side down for mounting.

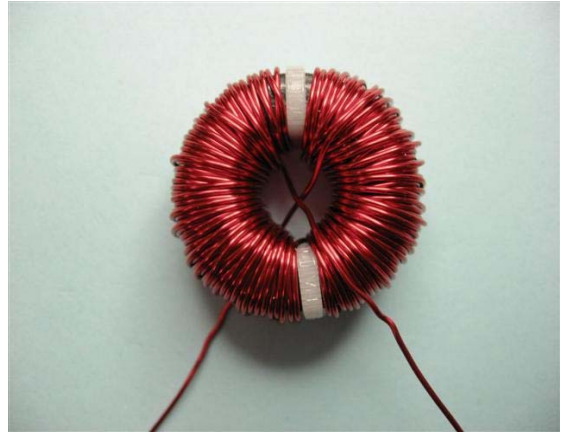
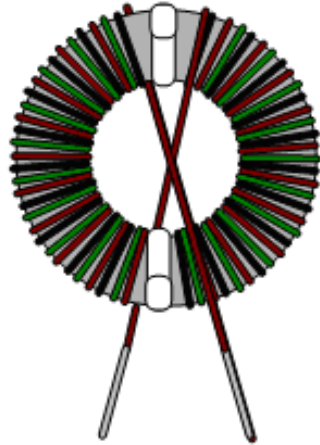

- Place wound toroid into the mount with 'top' side down.
- Solder the leads to pins 1 and 4 of mounting base item [3].
Secure the 'top' side of the inductor to the base by using High Temperature Epoxy item [4].

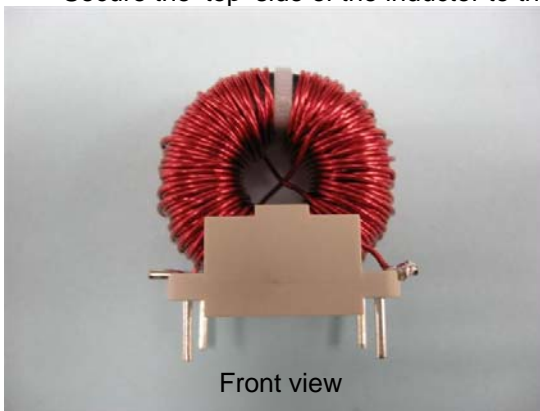

12 EMI Differential Inductor Specification

12.1 Electrical Diagram

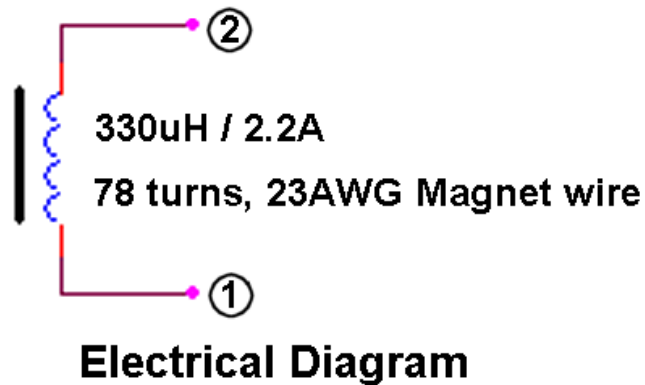

Figure 10 – Inductor Electrical Diagram.

12.2 Electrical Specifications

Primary Inductance	Pins 1-2 measured at kHz, 0.4 V RMS	330 μ H +8%
---------------------------	-------------------------------------	-----------------

12.3 Materials

Item	Description
[1]	Core: Micrometals T94-26
[2]	Magnet wire: #23 AWG insulated magnet wire, approximately 8 ft.
[3]	Hot-melt mounting glue



12.4 Inductor Winding Instruction

Obtain approximately 8 feet of item [2] and begin winding around toroidal core, item [1] as illustrated below:

Winding:

Begin winding a single layer circumferentially around the toroidal core.

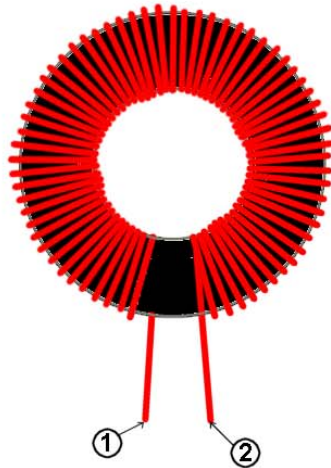

Continue winding layers on top of first layer in same direction until complete number of turns wound.

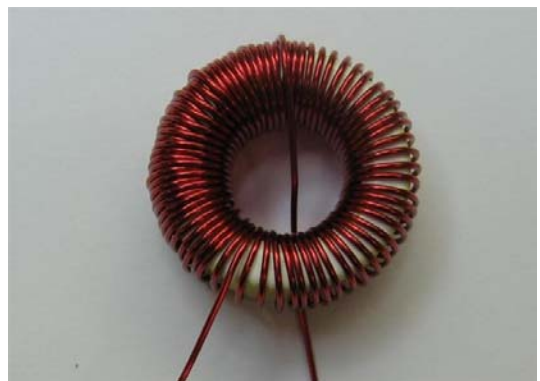
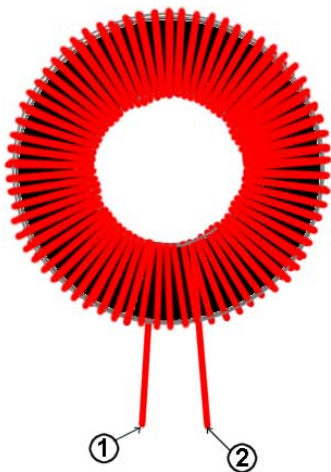

12.5 Inductance Value and Mounting

Verify inductor value is within electrical specifications.

Log measured inductance and self-resonant frequency for report.

Trim leads 1 and 2, tin leads and mount inductor on PC board by inserting leads through board, soldering leads, then stabilizing inductor mechanically by application of item [3] between inductor and PC board.



13 Heat Sink Specification

(Note: Heat sinks are designed for operation with open-frame convection cooling for 115 VAC operation at 100% rated load. Heat sink dimensions may be reduced for designs employing augmented [e.g.:forced-air] cooling.)

13.1 eSIP U1 Heat Sink

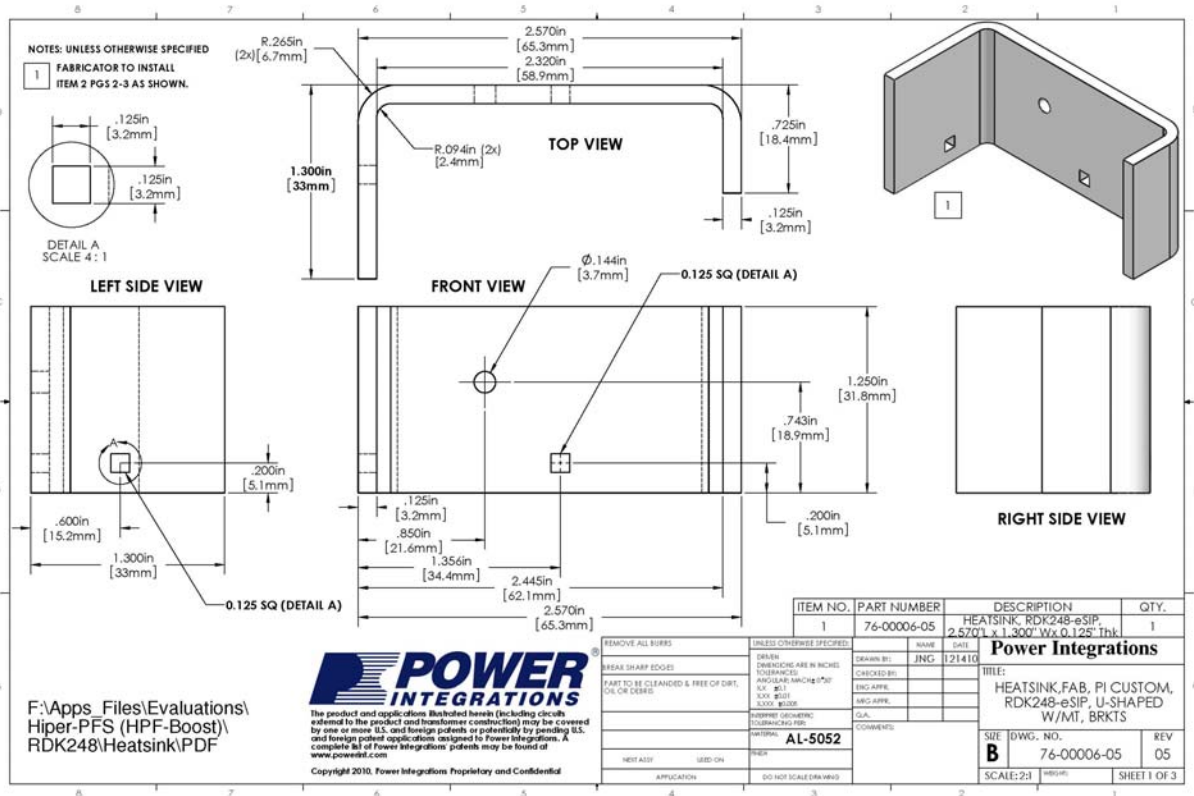

13.2 eSIP U1 Heat Sink Assembly

NOTES: UNLESS OTHERWISE SPECIFIED

1 FABRICATOR TO INSTALL ITEM 2 AS SHOWN.

(FOR FABRICATION REFERENCE TO INSTALL ITEM 2.)

ITEM NO.	PART NUMBER	DESCRIPTION	QTY.
1	76-00006-05	HEATSINK, RDK248-eSIP, 2.570"L x 1.300" Wx 0.125" Thk	1
2	60-00016-00	TERMINAL, EYELET, ZIERICK PN 190	2

F:\Apps_Files\Evaluations\Hiper-PFS (HPF-Boost)\RDK248\Heatsink\PDF

POWER INTEGRATIONS

The product and applications illustrated herein (including circuits external to the product and transformer construction) may be covered by one or more U.S. and foreign patents or potentially by pending U.S. and foreign patent applications assigned to Power Integrations. A complete list of Power Integrations' patents may be found at www.powerint.com

Copyright 2010, Power Integrations
Proprietary and Confidential

REMOVE ALL BURRS	UNLESS OTHERWISE SPECIFIED:	NAME	DATE	Power Integrations TITLE: HEATSINK, FAB, PI CUSTOM, RDK248-ZIERICK, U-SHAPED W/MTG, BRKTS SIZE DWG. NO. REV A 76-00006-05 05 SCALE: 1:1 WEIGHT: SHEET 2 OF 3
BREAK SHARP EDGES	DRIVEN DIMENSIONS ARE IN INCHES	DRAWN BY: JNG	121410	
PART TO BE CLEANED & FREE OF DIRT, OIL OR DEBRIS	TOLERANCES: ANGULAR: MACH ± 0°30' XX ±0.1 XXX ±0.01 XXXX ±0.005	CHECKED BY:		
	ASME Y14.5	ENG APPR.		
NEXT ASSY	MATERIAL	MFG APPR.		
USED ON	FINISH	Q.A.		
APPLICATION	DO NOT SCALE DRAWING	COMMENTS:		



13.3 eSIP U1 Heat Sink Assembly and Mounting Hardware

NOTES: UNLESS OTHERWISE SPECIFIED

1 PUNCHED SIDE OF ITEM 7 TOWARD HEAT PAD ITEM 8.

(FOR ASSEMBLY REFERENCE)

ITEM NO.	PART NUMBER	DESCRIPTION	QTY.
1	75-00003-00	SCREW MACHINE PHIL#4-40 X .3/8 SS	1
2	75-00161-00	WASHER SHOULDER #4, 0.095 SHOULDER x 0.117 Dia, PPS	1
3	60-00042-00	EDGE CLIP, 20.76 mm L x 8mm W x 0.015 mm	1
4	10-00369-00	HiperPFS, PFS708EG, eSIP7/6-TH	1
5	66-00084-00	THERMALLY CONDUCTIVE SILICONE GREASE	1
6	75-00162-00	WASHER TEFLON #6, ID 0.156, OD 0.312, THK 0.031	1
7	61-00040-05	HEATSPREADER, CUSTOM, AL, 3003, 0.030" THK.	1
8	66-00083-00	HEATPAD 10-247.006" K10	1
9	76-00006-05	HEATSINK, RDK248-eSIP, 2.570"L x 1.300" Wx 0.125" Thk	1
10	75-00068-00	NUT, HEX, KEP 4-40	1

REMOVE ALL BURRS	UNLESS OTHERWISE SPECIFIED	NAME	DATE	Power Integrations
BREAK SHARP EDGES	TOLERANCES ARE IN INCHES	DRAWN BY:	JNG 12/14/10	
PART TO BE CLEANED & FREE OF DIRT, OIL OR DEBRIS	FINISHES: ANGULAR MATCH@90° S.D. .015 S.U. .010 S.V. .010	CHECKED BY:		TITLE:
	FORMED TO MEETING TOLERANCING PER:	ENG APPR:		HEATSINK, ASSY, RDK248 eSIP U SHAPED W/MTG BRKTS
		MFG APPR:		
		QA:		SIZE
		COMMENTS:		DWG. NO.
				76-00006-05
				REV
				05
				SCALE: 1:2
				SHEET 3 OF 3

F:\Apps_Files\Evaluations\Hiper-PFS (HPF-Boost)\RDK248\Heatsink\PDF

POWER INTEGRATIONS

The product and application included herein (including circuitry extended to the product and transformer construction) may be covered by one or more U.S. and foreign patents or potentially by pending U.S. and foreign patent applications assigned to Power Integrations. A complete list of Power Integrations' patents may be found at www.powerint.com

Copyright 2010, Power Integrations Proprietary and Confidential



13.4 Bridge BR1 Heat Sink

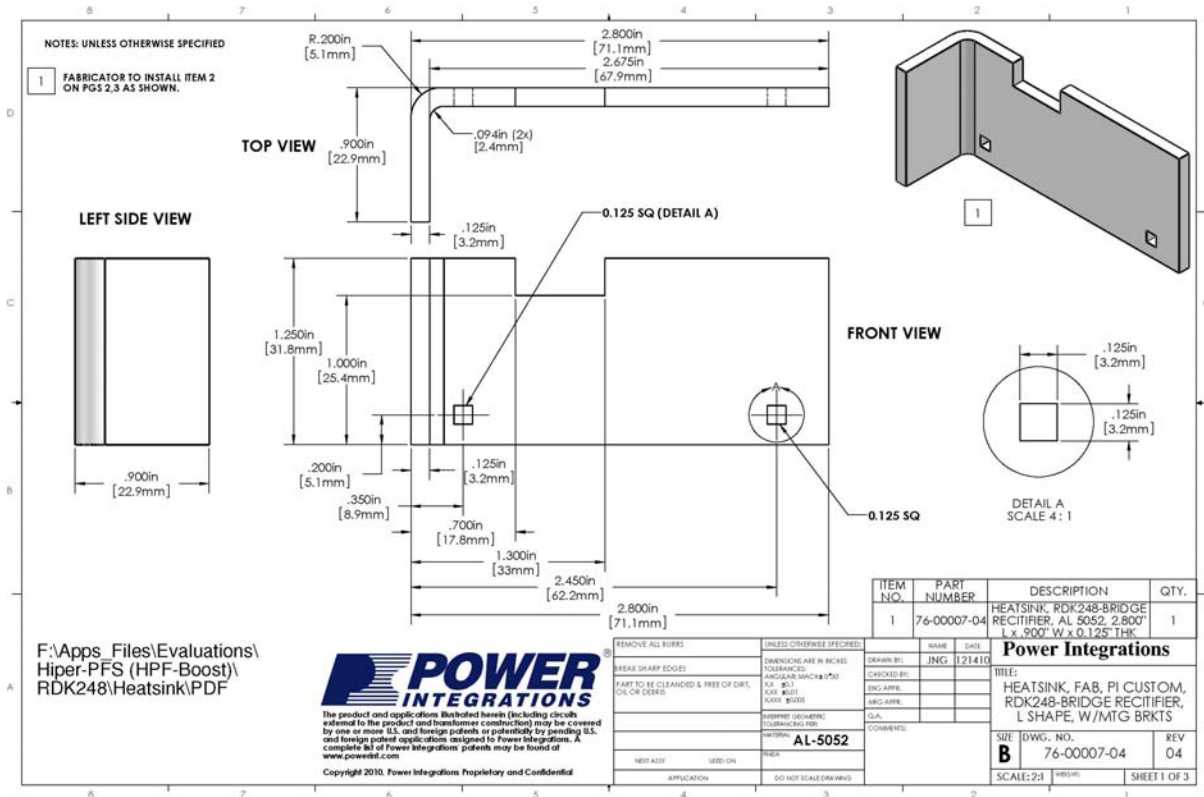

13.5 Bridge BR1 Heat Sink Assembly

NOTES: UNLESS OTHERWISE SPECIFIED

1 FABRICATOR TO INSTALL ITEM 2 AS SHOWN.

(FOR FABRICATION REFERENCE TO INSTALL ITEM 2)

ITEM NO.	PART NUMBER	DESCRIPTION	QTY.
1	76-00007-04	HEATSINK, RDK248-BRIDGE RECITIFIER, AL 5052, 2.800" L x 900" W x 0.125" THK	1
2	60-00016-00	TERMINAL, EYELET, ZIERICK PN 190	2

F:\Apps_Files\Evaluations\
Hiper-PFS (HPF-Boost)\
RDK248\Heatsink\PDF

REMOVE ALL BURRS	UNLESS OTHERWISE SPECIFIED:	NAME	DATE	Power Integrations
BREAK SHARP EDGES	DIMENSIONS ARE IN INCHES	DRAWN BY: JNG	121410	
PART TO BE CLEANED & FREE OF DIRT, OIL OR DEBRIS	TOLERANCES: ANGULAR: MACH ± 0°30' XX ±0.1 XXX ±0.01 XXXX ±0.005	CHECKED BY:		TITLE:
	ASME Y14.5	ENG APPR.		ASSY-HEATSINK-RDK248-BRIDGE RECITIFIER-ZIERICK
NEXT ASSY	MATERIAL	MFG APPR.		Q.A.
USED ON	FINISH	COMMENTS:		SIZE DWG. NO. REV
APPLICATION	DO NOT SCALE DRAWING			A 76-00007-04 04
				SCALE: 1:1 WEIGHT: SHEET 2 OF 3

5 4 3 2 1



13.6 Bridge BR1 Heat Sink Assembly and Mounting Hardware Assembly

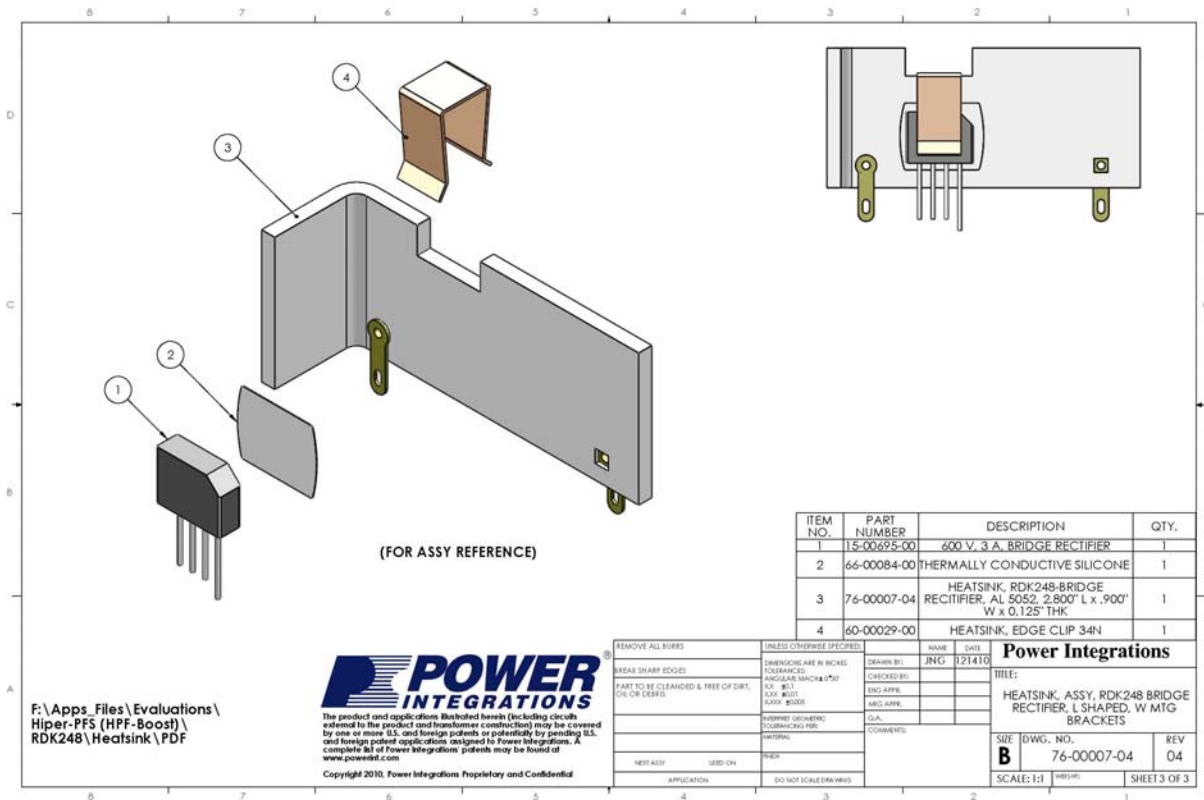

14 Performance Data

All measurements performed at room temperature, 60 Hz input frequency for voltages below 150 VAC and input frequency of 50 Hz for 150 VAC and higher.

All performance data is with Thermistor RT1 in-circuit to represent a low-cost configuration.

14.1 Auxiliary Supply Efficiency (with PFC disabled)

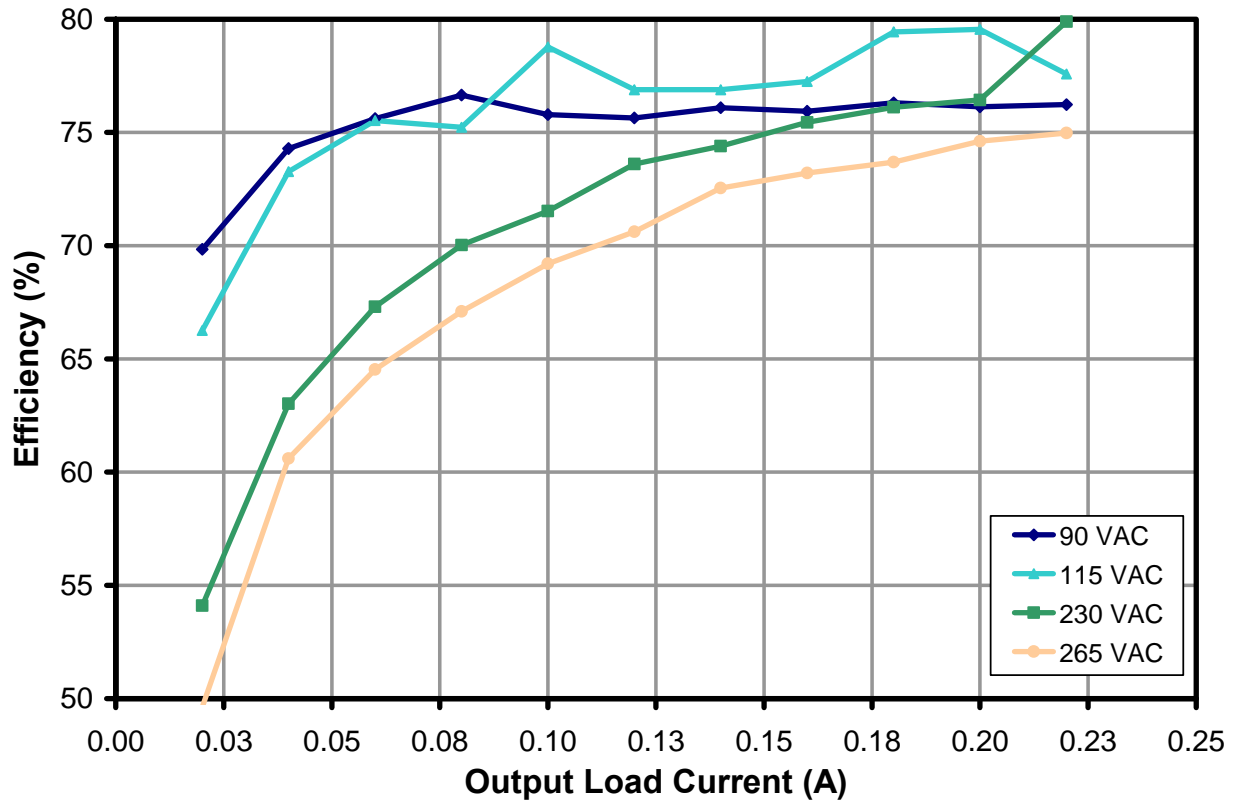

Figure 11 – Auxiliary Supply Efficiency, PFC Disabled.



14.2 Auxiliary Supply Load Regulation (with PFC disabled)

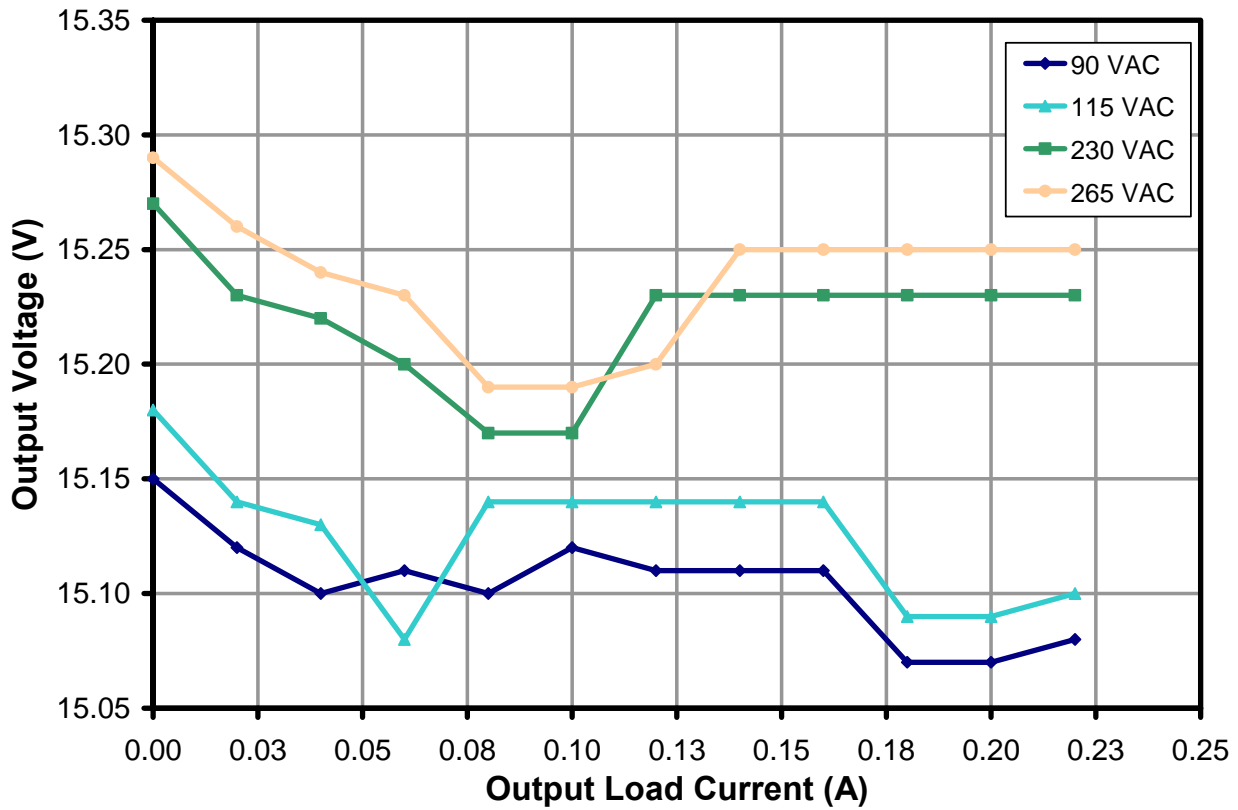

Figure 12 – Auxiliary Supply Load Regulation.



14.3 Auxiliary Supply Line Regulation (with PFC disabled)

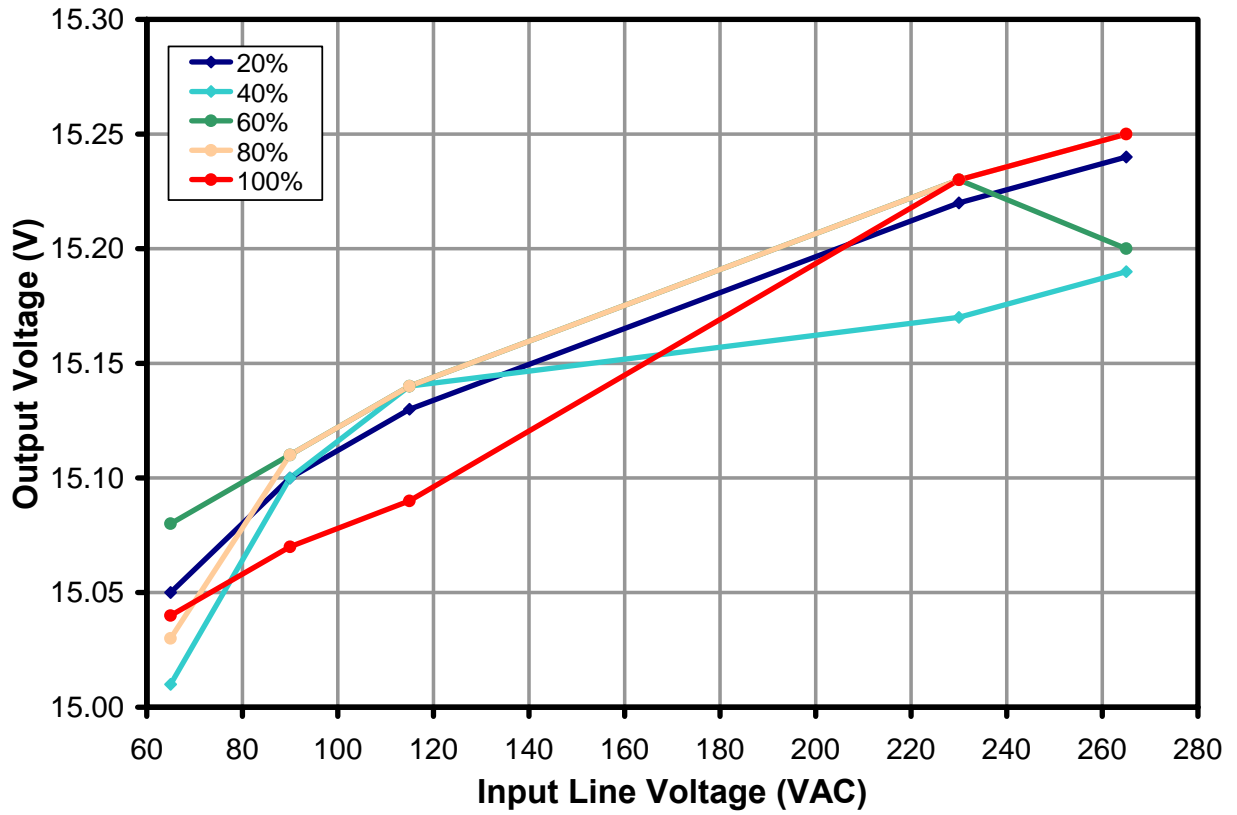

Figure 13 – Auxiliary Supply Line Regulation.



14.4 No-Load Input Power

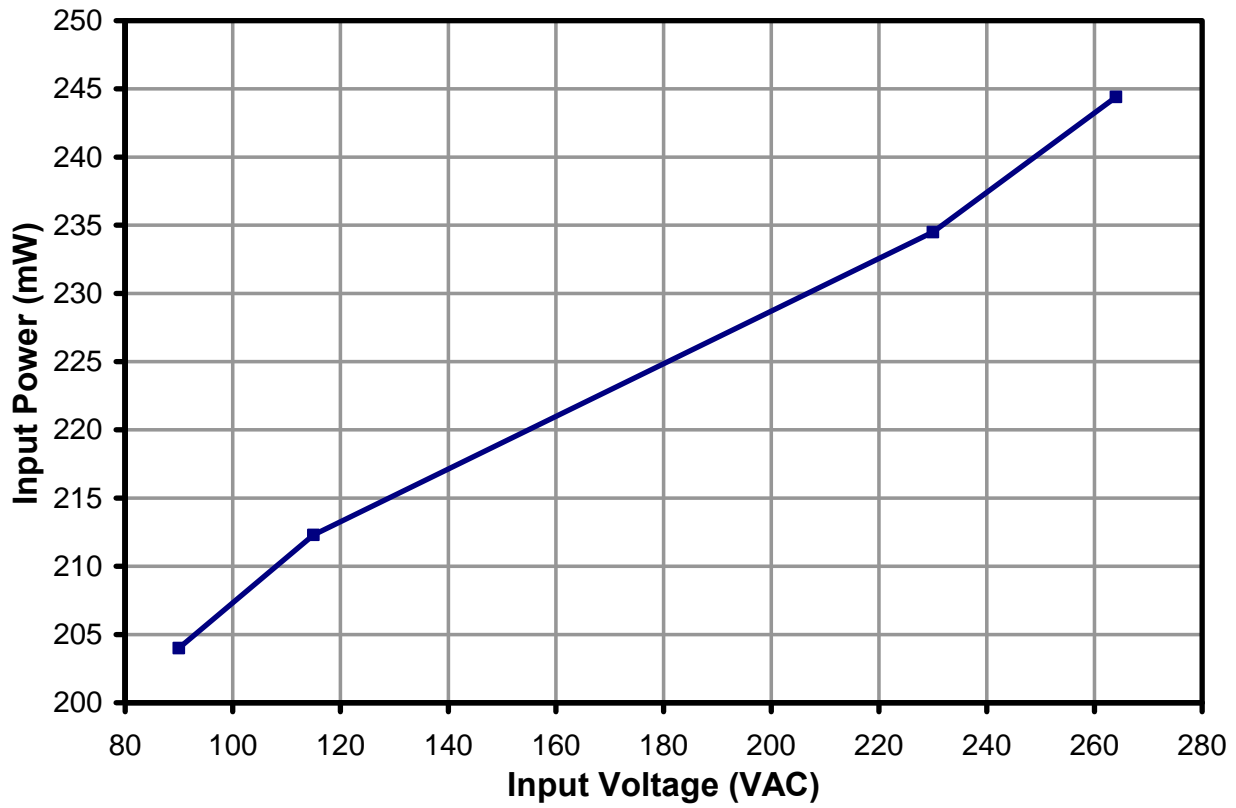

Figure 14 – No-Load Input Power.



14.5 PFC Efficiency (with RT1 in-circuit)

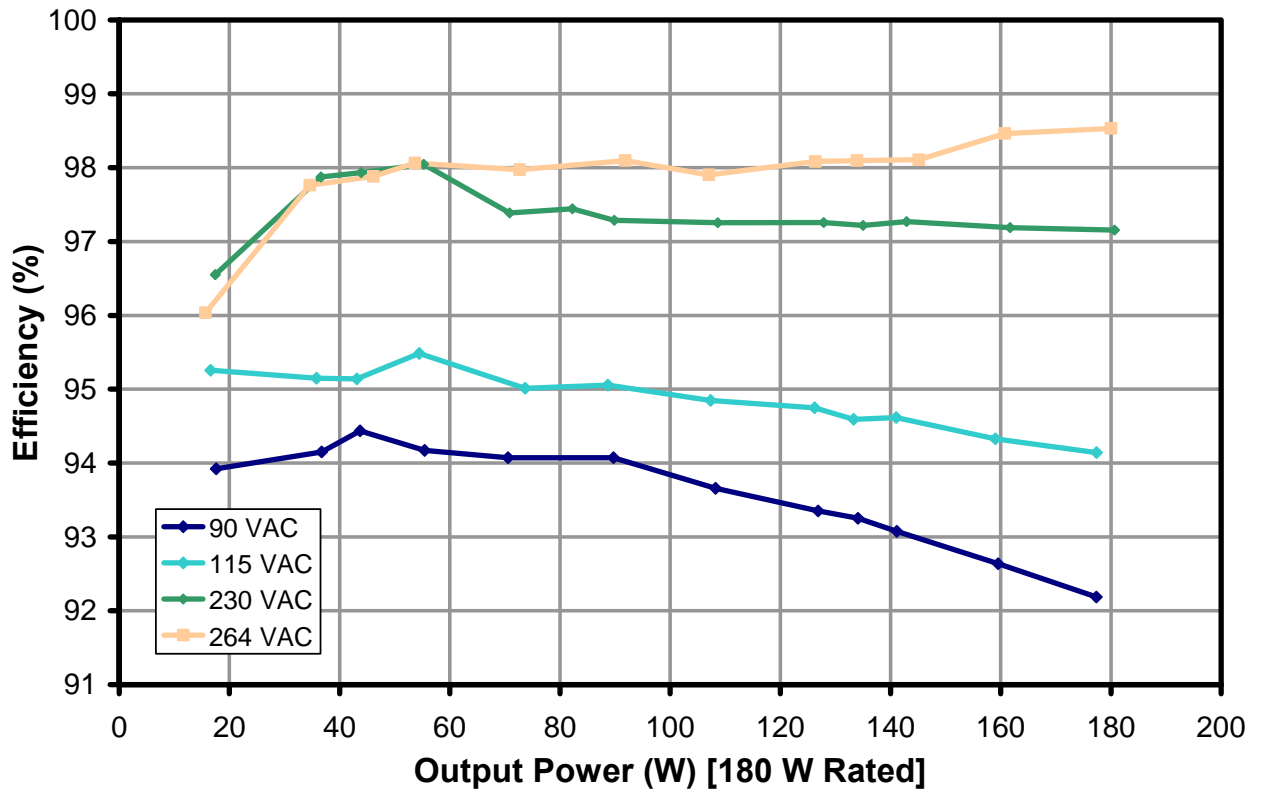

Figure 15 – Efficiency vs. Output Power.



14.6 Input Power Factor

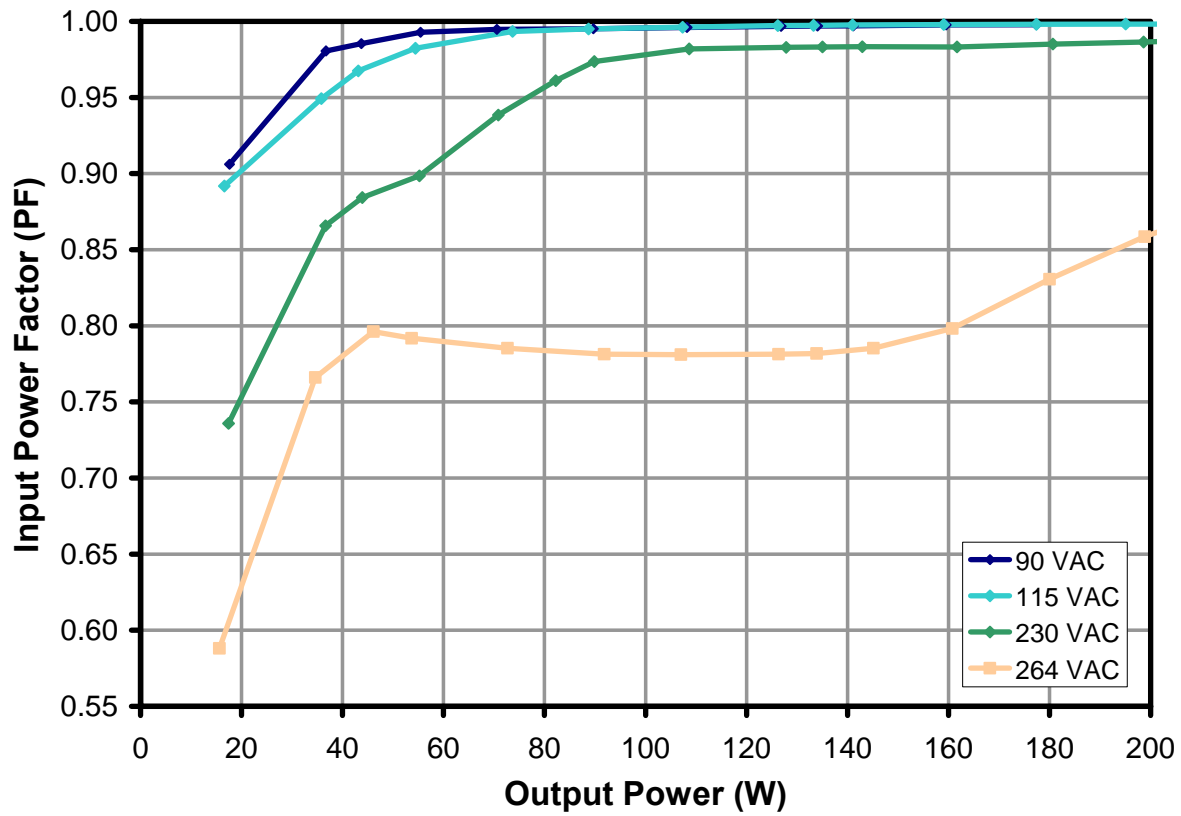

Figure 16 – Input Power Factor vs. Output Power.



14.7 Regulation

14.7.1 Load

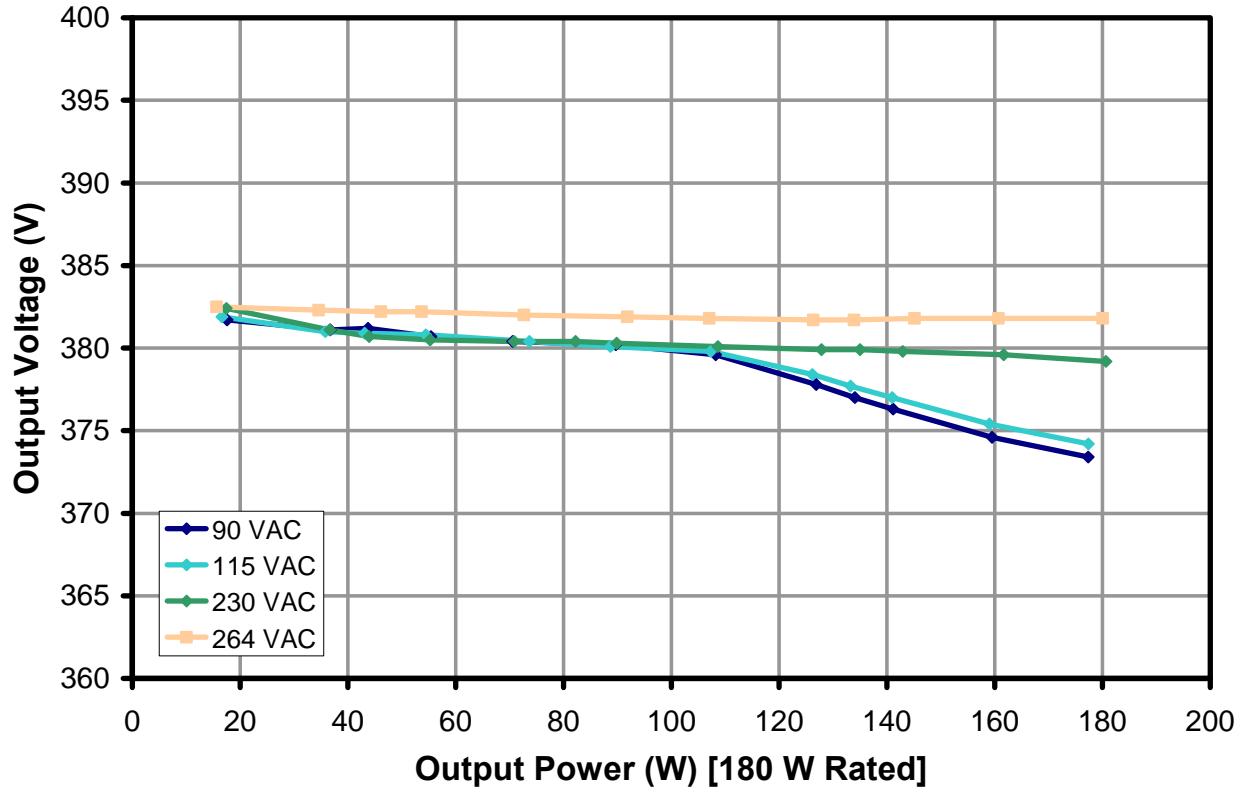

Figure 17 – Load Regulation.



14.7.2 Line

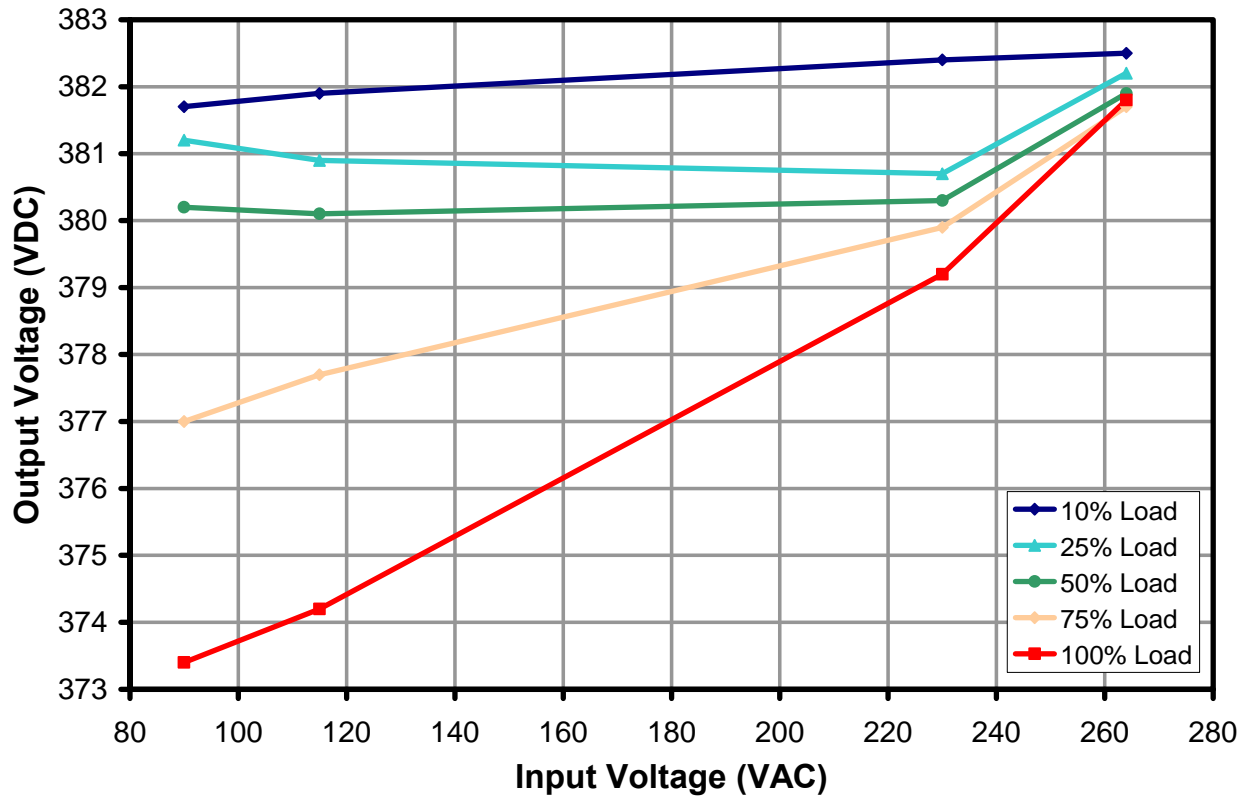

Figure 18 – Line Regulation.



14.7.3 Overload

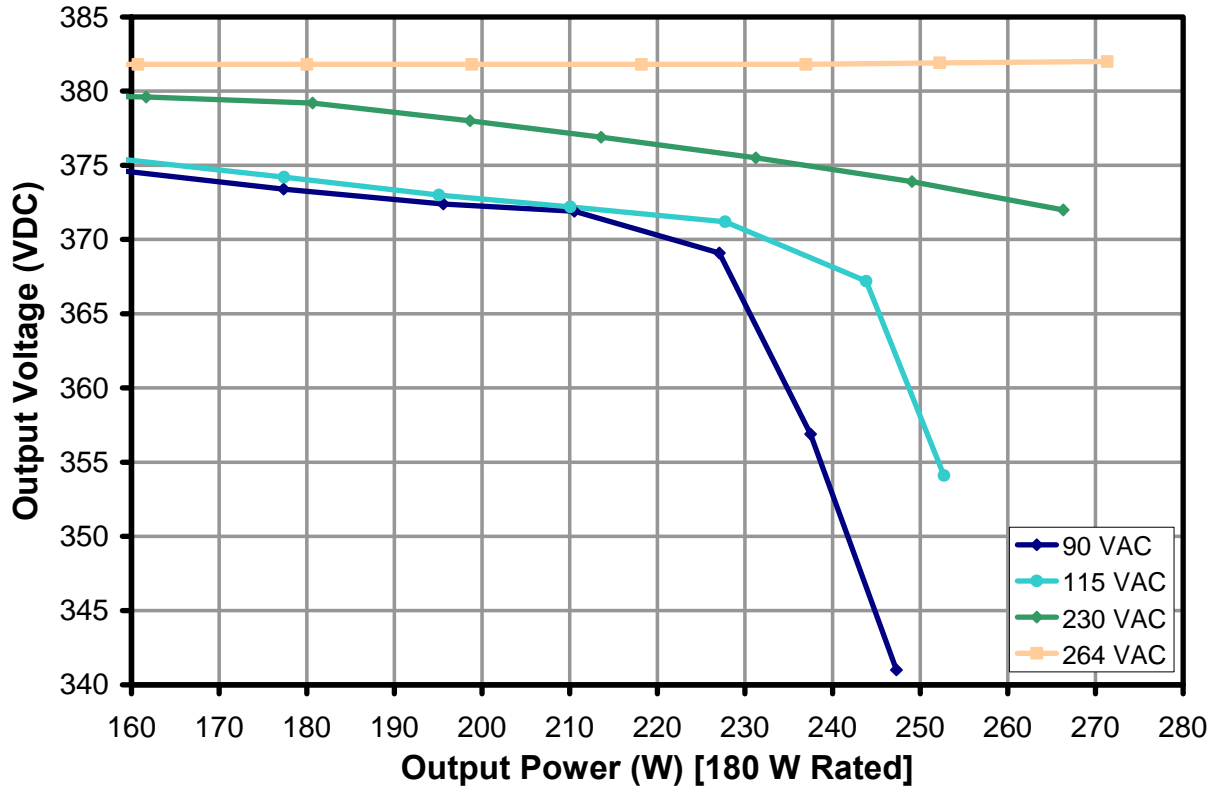

Figure 19 – Overload Regulation.



14.8 THDi

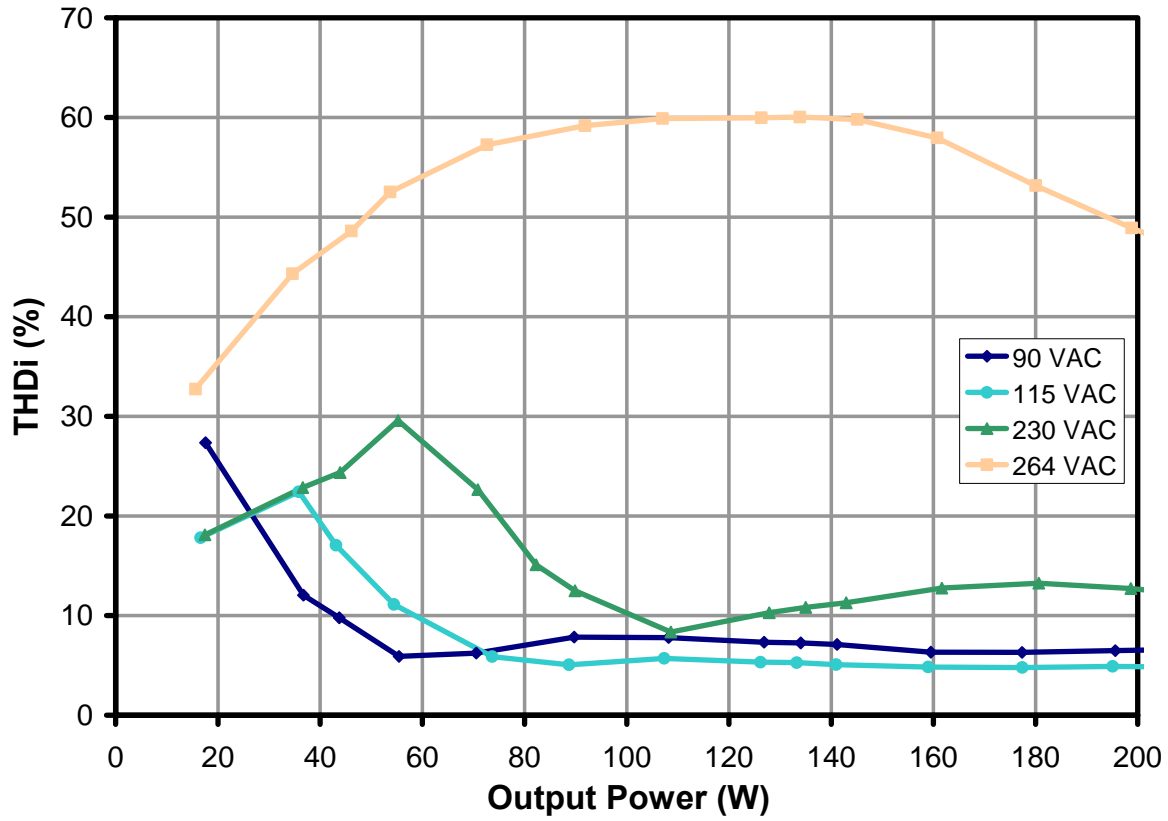

Figure 20 – Input Current THD vs. Load.



14.9 Input Current Harmonic Distortion (IEC 61000-3-2 Class-D)

Measured at 230 VAC Input 50Hz

14.9.1 50% Load at Output

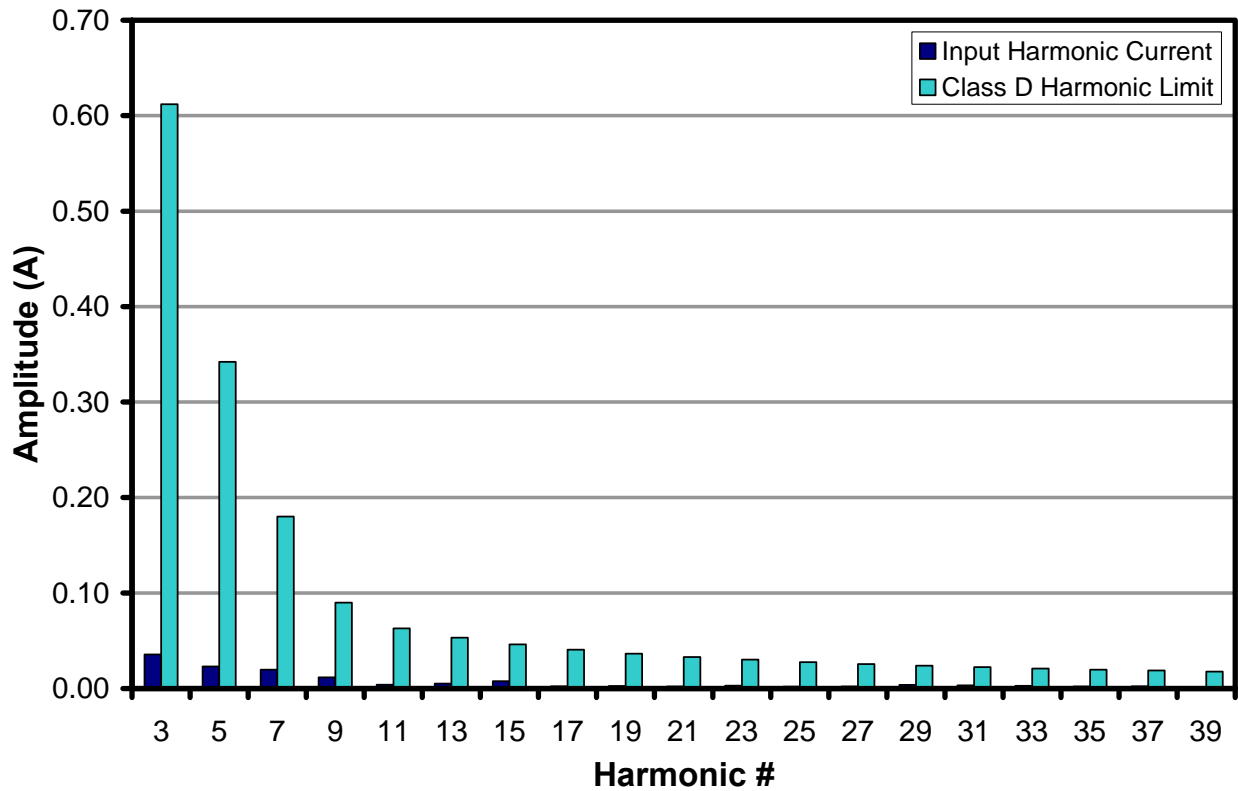

Figure 21 – Amplitude of Input Current Harmonics for 50% Load at 230 VAC Input.



14.9.2 100% Load at Output

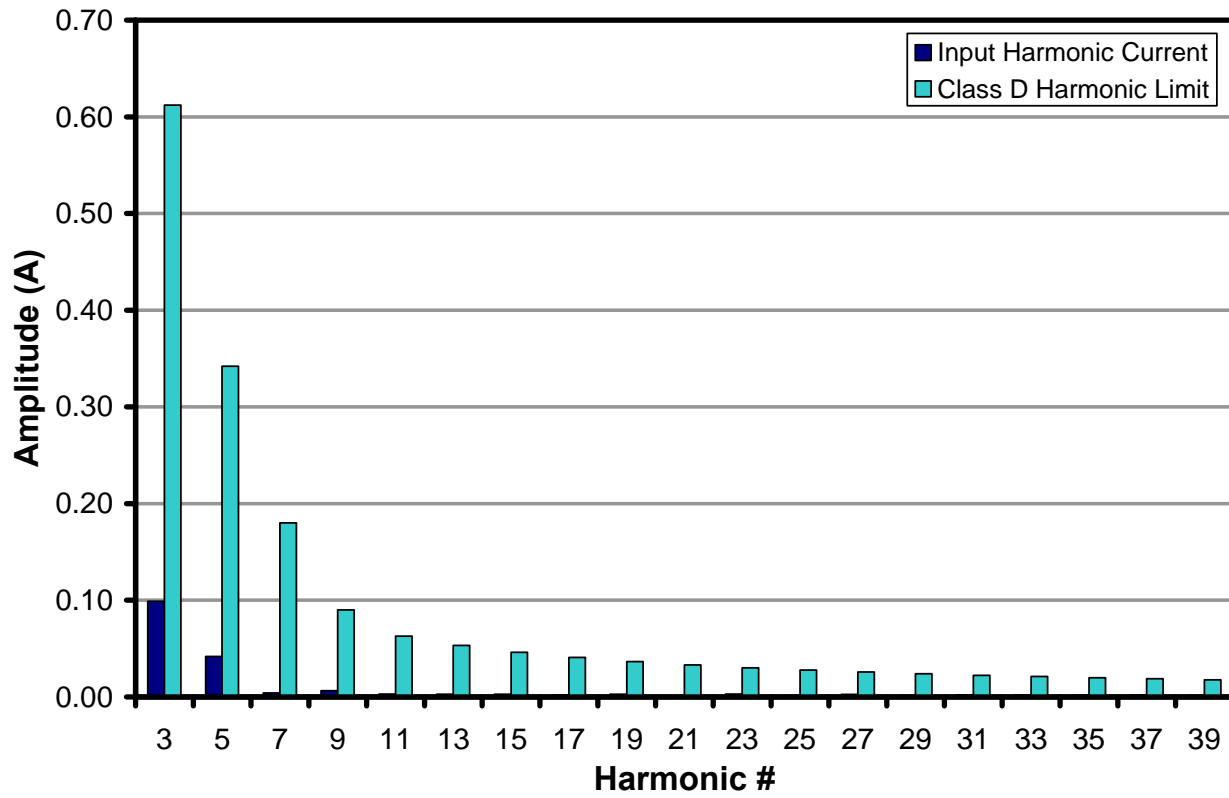

Figure 22 – Amplitude of Input Current Harmonics for 100% Load at 230 VAC Input.



15 Thermal Performance

The unit was allowed to reach thermal equilibrium prior to thermal measurement with a FLIR camera. Table 1 shows full load temperature of key components measured at equilibrium, room temperature and without any forced air cooling. Tests were performed with auxiliary supply loaded to 200 mA.

Temperature (°C) 180 W Load		
Item	115 VAC	230 VAC
Ambient	23.4	23.1
PFS708EG (U1)	97.2	57.8
Inductor (L5)	68.8	51.6
Output Rectifier (D2)	87.8	63
Output Capacitor (C15)	55.5	44.0
Switching Capacitor (C7)	70.6	49.0
Bridge (BR1)	88.7	57.3
Input X2 Capacitor (C3)	35.7	30.5
Input X2 Capacitor (C6)	59.0	42.1
Input CM Choke(L1)	49.0	34.2
Input DM Choke (L2)	55.0	36.0
Thermistor (RT1)	160	112
Heat-Sink (HS1) [eSIP]	75.7	50.8
Heat Sink (HS2) [BR1]	72.8	50.0

Table 1 – Steady State Thermal Performance.



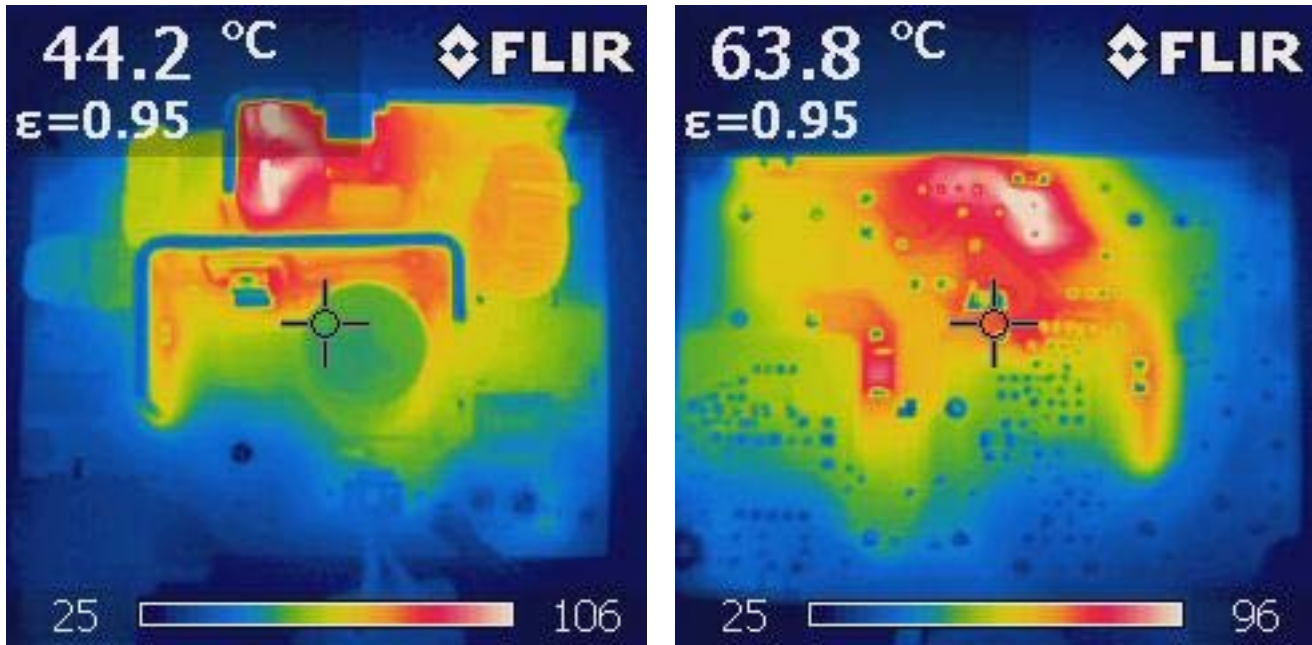

Figure 23 – Infra-Red Image of the Top and Bottom of the Board at Thermal Equilibrium, 115 VAC, Full Load, No Forced-Air Flow, 25°C Ambient.

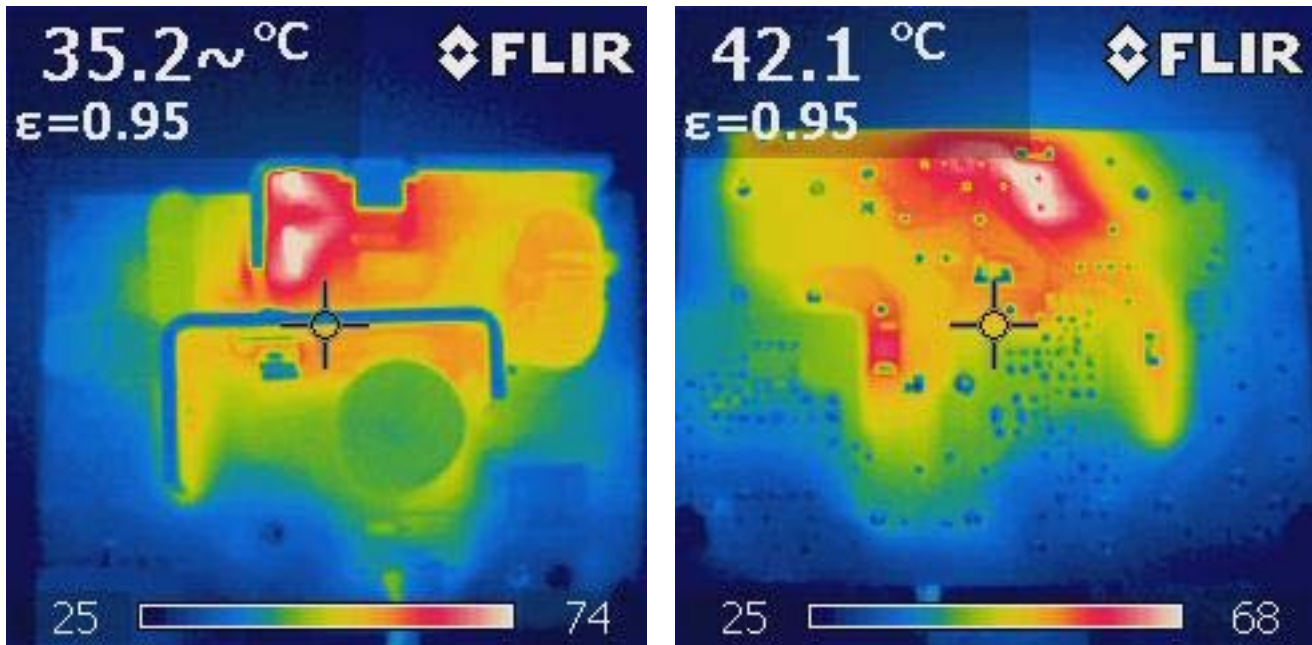

Figure 24 – Infra-Red Image of the Top and Bottom Sides of the Board at Thermal Equilibrium, 230 VAC, Full Load, No Forced-Air Flow, 25°C Ambient.

16 Waveforms

16.1 Auxiliary +15 V Supply

16.1.1 Load Transient Response

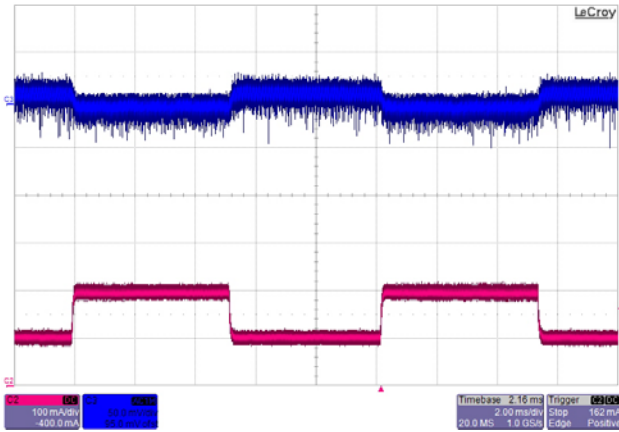

Figure 25 – Transient Response, 115 VAC,
 50%-100%-50% Load Step.
 Upper: V_{OUT} , 50 mV / div., AC Coupled
 Lower: I_{LOAD} 100 mA / div., 2 ms / div.

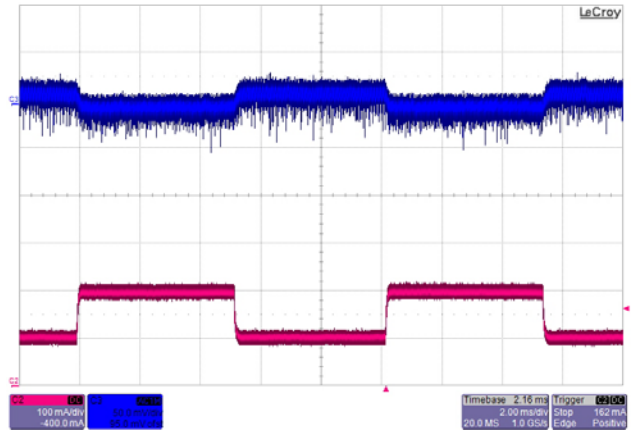

Figure 26 – Transient Response, 230 VAC / 50 Hz.,
 50-100-50% Load Step.
 Upper: V_{OUT} , 50 mV / div., AC Coupled
 Lower: I_{LOAD} 100 mA, 2 ms / div.



16.2 Input Current at 115 VAC and 60 Hz

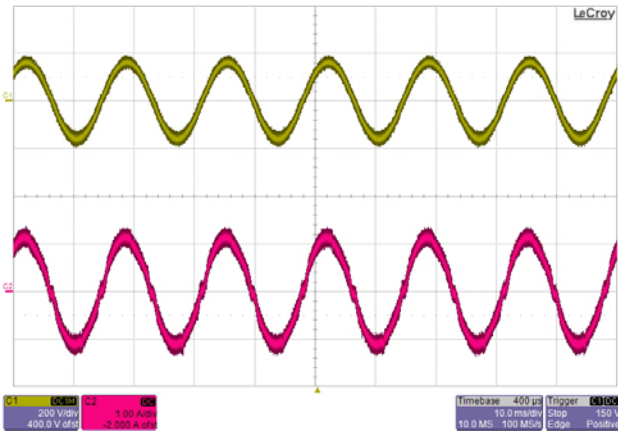

Figure 27 – 115 VAC, 50% Load.
Upper: V_{IN} , 200 V / div.
Lower: I_{IN} , 1 A, 10 ms / div.

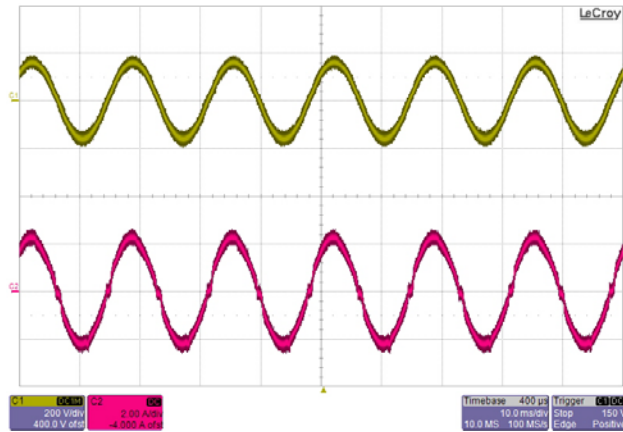

Figure 28 – 115 VAC, 100% Load.
Upper: V_{IN} , 200 V / div.
Lower: I_{IN} , 2 A, 10 ms / div.

16.3 Input Current at 230 VAC and 50 Hz

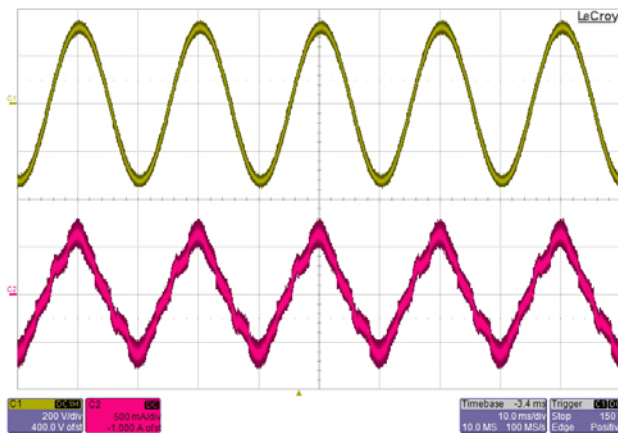

Figure 29 – 230 VAC, 50% Load.
Upper: V_{IN} , 200 V / div.
Lower: I_{IN} , 500 mA, 10 ms / div.

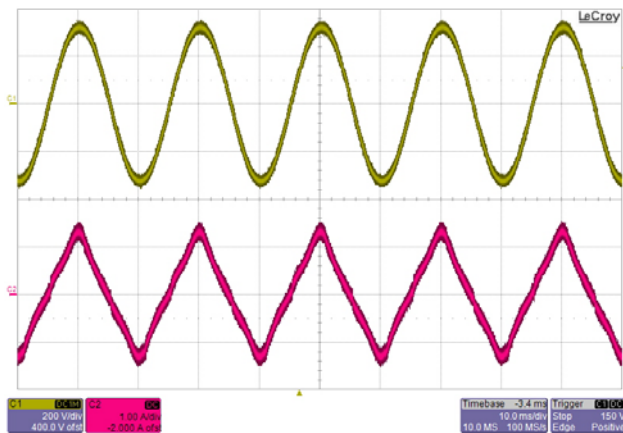

Figure 30 – 230 VAC, 100% Load.
Upper: V_{IN} , 200 V / div.
Lower: I_{IN} , 1 A, 10 ms / div.



16.4 Start-up at 90 VAC and 60 Hz

Load in CC mode during turn-on of PFC

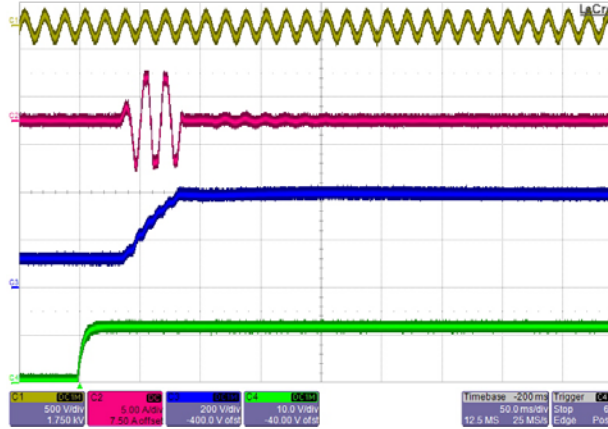

Figure 31 – 90 VAC, No-Load.
 Upper: V_{IN} , 500 V / div.
 Second: I_{IN} , 5 A / div.,
 Third: V_{OUT} , 200 V / div.
 Lower: V_{CC} , 10 V, 50 ms / div.

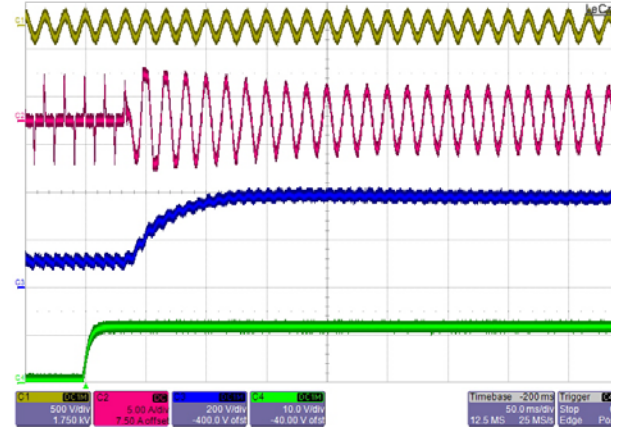

Figure 32 – 90 VAC, Full Load.
 Upper: V_{IN} , 500 V / div.
 Second: I_{IN} , 5 A / div.,
 Third: V_{OUT} , 200 V / div.
 Lower: V_{CC} , 10 V, 50 ms / div.

16.5 Start-up at 115 VAC and 60 Hz

Load in CC mode during turn-on of PFC

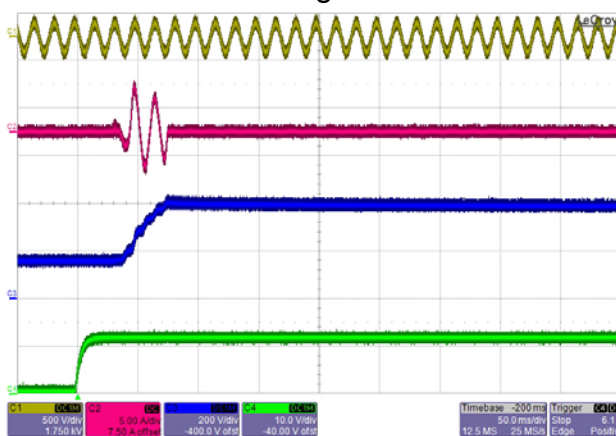

Figure 33 – 115 VAC, No-Load.
 Upper: V_{IN} , 500 V / div.
 Second: I_{IN} , 5 A / div.
 Third: V_{OUT} , 200 V / div.
 Lower: V_{CC} , 10 V, 50 ms / div.

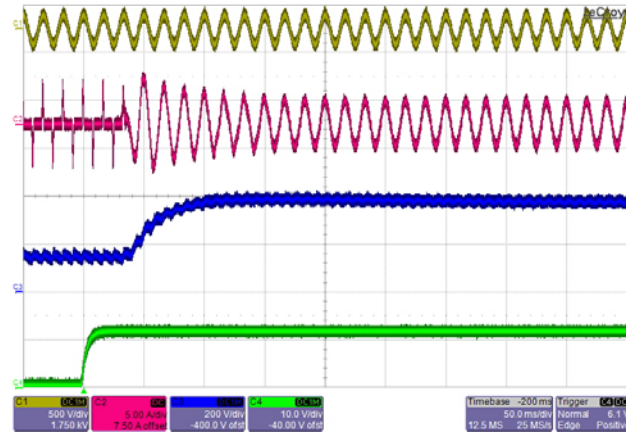

Figure 34 – 115 VAC, Full Load.
 Upper: V_{IN} , 500 V / div.
 Second: I_{IN} , 5 A / div.
 Third: V_{OUT} , 200 V / div.
 Lower: V_{CC} , 10 V, 50 ms / div.



16.6 Start-up at 230 VAC and 50 Hz

Load in CC mode during turn-on of PFC

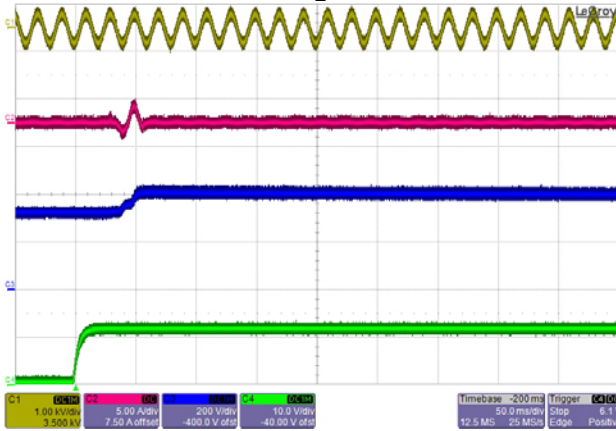

Figure 35 – 230 VAC, No-load.
 Upper: V_{IN} , 1 kV / div.
 Second: I_{IN} , 5 A / div.
 Third: V_{OUT} , 200 V / div.
 Lower: V_{CC} , 10 V, 50 ms / div.

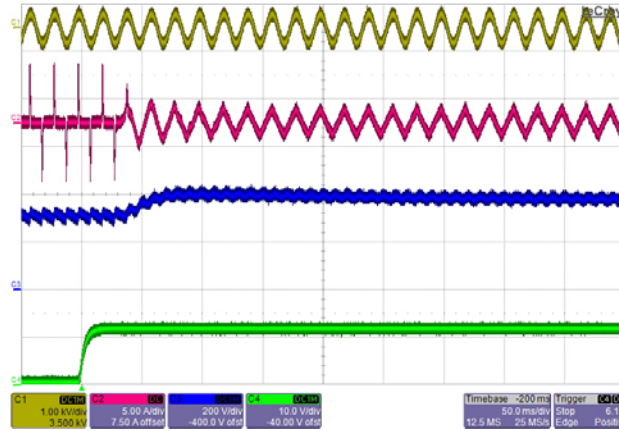

Figure 36 – 230 VAC, Full Load.
 Upper: V_{IN} , 1 kV / div.
 Second: I_{IN} , 5 A / div.
 Third: V_{OUT} , 200 V / div.
 Lower: V_{CC} , 10 V, 50 ms / div.

16.7 Start-up at 264 VAC and 50 Hz

Load in CC mode during turn-on of PFC

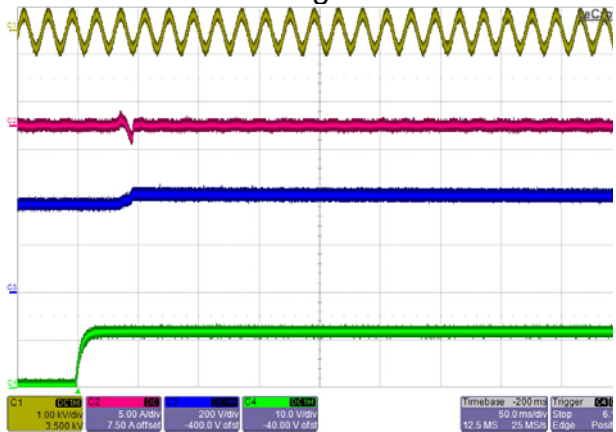

Figure 37 – 264 VAC, No-load.
 Upper: V_{IN} , 1 kV / div.
 Second: I_{IN} , 5 A / div.
 Third: V_{OUT} , 200 V / div.
 Lower: V_{CC} , 10 V, 50 ms / div.

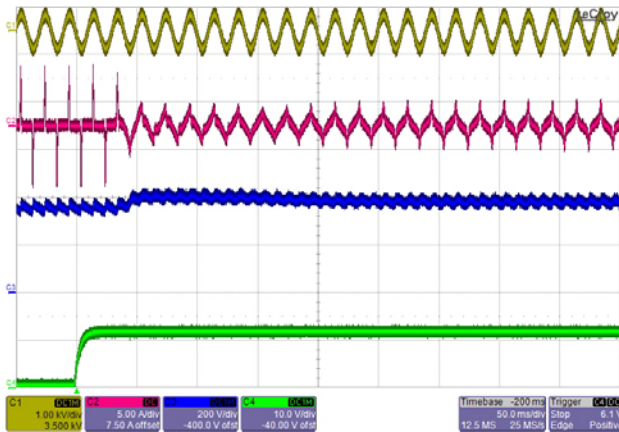

Figure 38 – 264 VAC, Full Load.
 Upper: V_{IN} , 1 kV / div.
 Second: I_{IN} , 5 A / div.
 Third: V_{OUT} , 200 V / div.
 Lower: V_{CC} , 10 V, 50 ms / div.



16.8 Load Transient Response (90 VAC, 60 Hz)

In the figures shown below, signal averaging was used to better enable viewing the load transient response. The oscilloscope was triggered using the load current step as a trigger source. Since the output switching and line frequency occur essentially at random with respect to the load transient, contributions to the output ripple from these sources will average out, leaving the contribution only from the load step response.

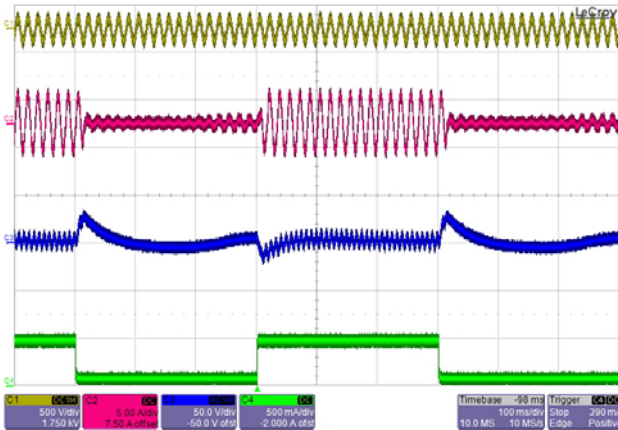

Figure 39 – Transient Response, 90 VAC,
10-100-10% Load Step.
Upper: V_{IN} , 500 V / div.
Second: I_{IN} , 5 A / div.
Third: V_{OUT} (AC Coupled), 50 V / div.
Lower: I_{LOAD} 500 mA, 100 ms / div.

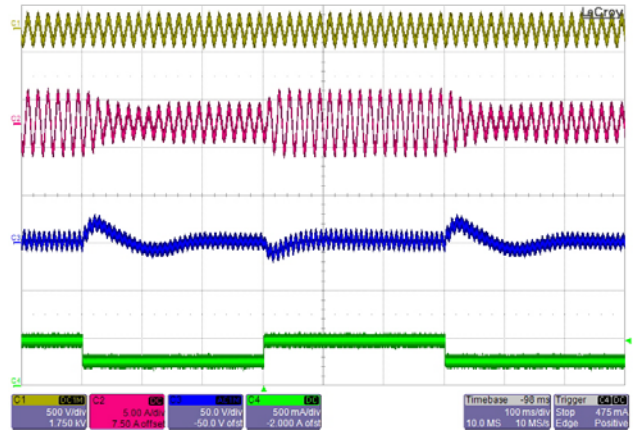

Figure 40 – Transient Response, 90 VAC,
50-100-50% Load Step
Upper: V_{IN} , 500 V / div.
Second: I_{IN} , 5 A / div.
Third: V_{OUT} (AC Coupled), 50 V / div.
Lower: I_{LOAD} 500 mA, 100 ms / div.

16.9 Load Transient Response (115 VAC, 60 Hz)

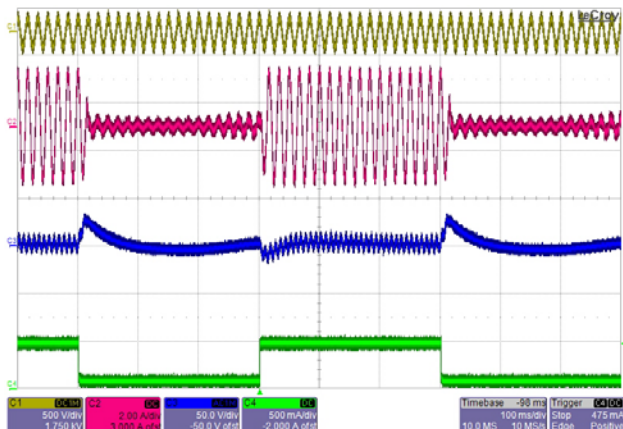

Figure 41 – Transient Response, 115 VAC,
10-100-10% Load Step.
Upper: V_{IN} , 500 V / div.
Second: I_{IN} , 2 A / div.
Third: V_{OUT} (AC Coupled), 50 V / div.
Lower: I_{LOAD} 500 mA, 100 ms / div.

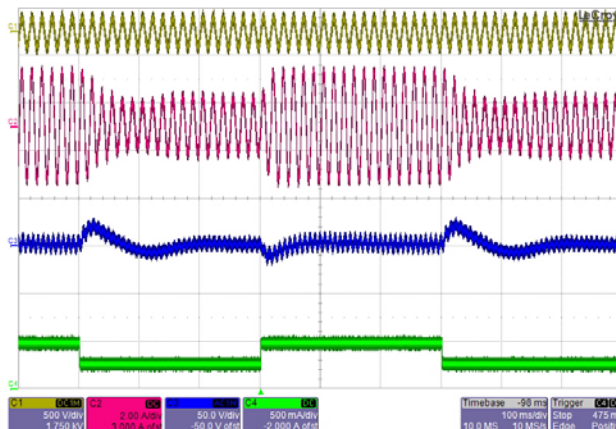

Figure 42 – Transient Response, 115 VAC,
50-100-50% Load Step
Upper: V_{IN} , 500 V / div.
Second: I_{IN} , 2 A / div.
Third: V_{OUT} (AC Coupled), 50 V / div.
Lower: I_{LOAD} 500 mA, 100 ms / div.

16.10 Load Transient Response (230 VAC, 50 Hz)

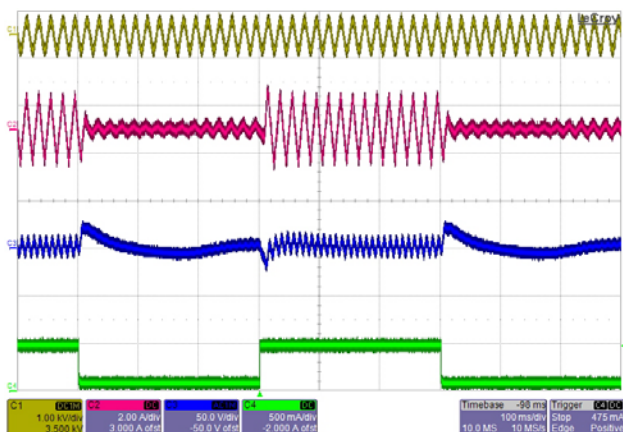

Figure 43 – Transient Response, 230 VAC,
10-100-10% Load Step.
Upper: V_{IN} , 1 kV / div.
Second: I_{IN} , 2 A / div.
Third: V_{OUT} (AC Coupled), 50 V / div.
Lower: I_{LOAD} 500 mA, 100 ms / div.

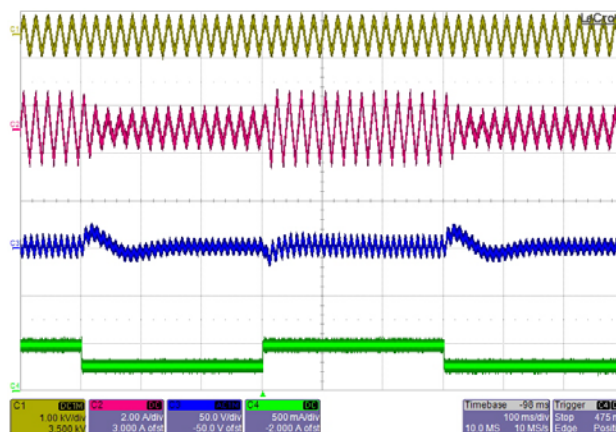

Figure 44 – Transient Response, 230 VAC,
50-100-50% Load Step
Upper: V_{IN} , 1 kV / div.
Second: I_{IN} , 2 A / div.
Third: V_{OUT} (AC Coupled), 50 V / div.
Lower: I_{LOAD} 500 mA, 100 ms / div.



16.11 Load Transient Response (264 VAC, 50 Hz)

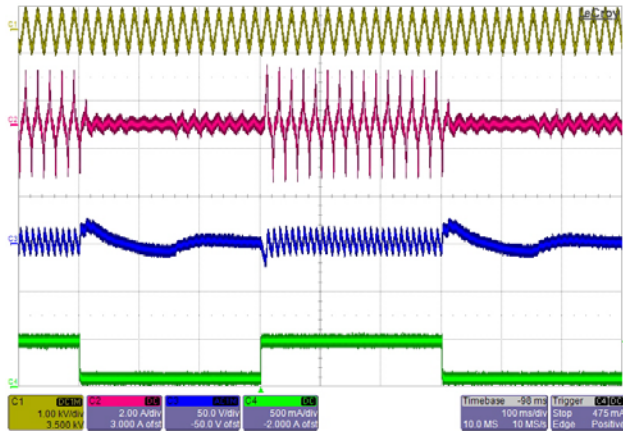

Figure 45 – Transient Response, 264 VAC, 10-100-10% Load Step.
 Upper: V_{IN} , 1 kV / div.
 Second: I_{IN} , 2 A / div.
 Third: V_{OUT} (AC Coupled), 50 V / div.
 Lower: I_{LOAD} 500 mA, 100 ms / div.

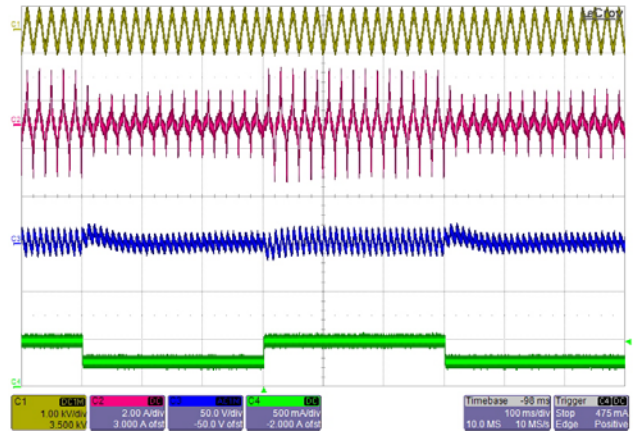

Figure 46 – Transient Response, 264 VAC, 50-100-50% Load Step.
 Upper: V_{IN} , 1 kV / div.
 Second: I_{IN} , 2 A / div.
 Third: V_{OUT} (AC Coupled), 50 V / div.
 Lower: I_{LOAD} 500 mA, 100 ms / div.

16.12 1000 ms Line Dropout (115 VAC / 60 Hz and 230 VAC / 50 Hz)

16.12.1 50% Load at Output

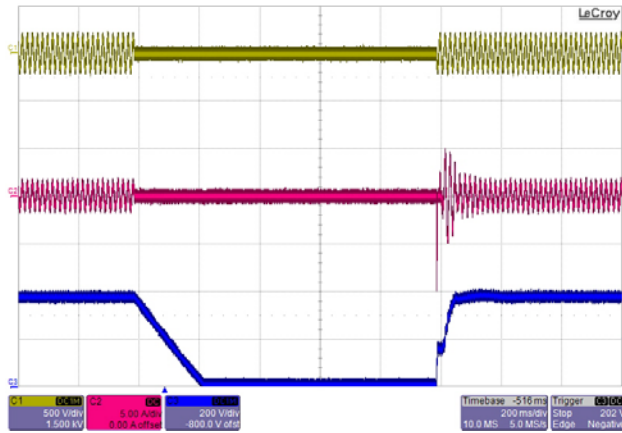

Figure 47 – Line Dropout 115 VAC, 1000 ms.
 Upper: V_{IN} , 500 V / div.
 Middle: I_{IN} , 5 A / div.
 Lower: V_{OUT} , 200 V, 200 ms / div.

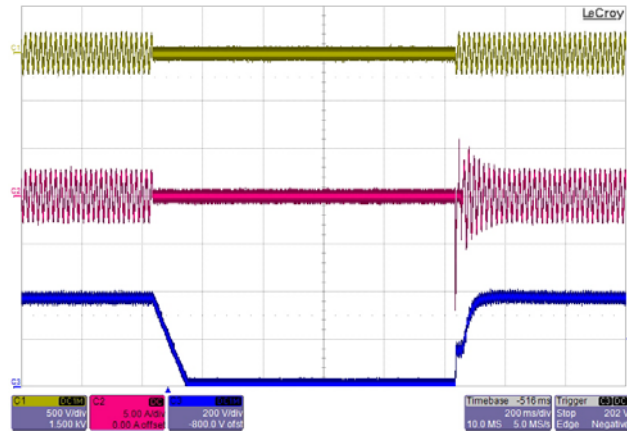

Figure 48 – Line Dropout 230 VAC, 1000 ms.
 Upper: V_{IN} , 500 V / div.
 Middle: I_{IN} , 5 A / div.
 Lower: V_{OUT} , 200 V, 200 ms / div.



16.12.2 Full Load at Output

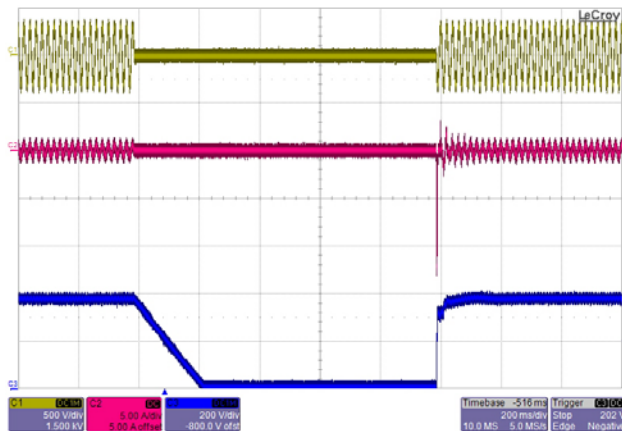

Figure 49 – Line Dropout 115 VAC, 1000 ms.
 Upper: V_{IN} , 500 V / div.
 Middle: I_{IN} , 5 A / div.
 Lower: V_{OUT} , 200 V, 200 ms / div.

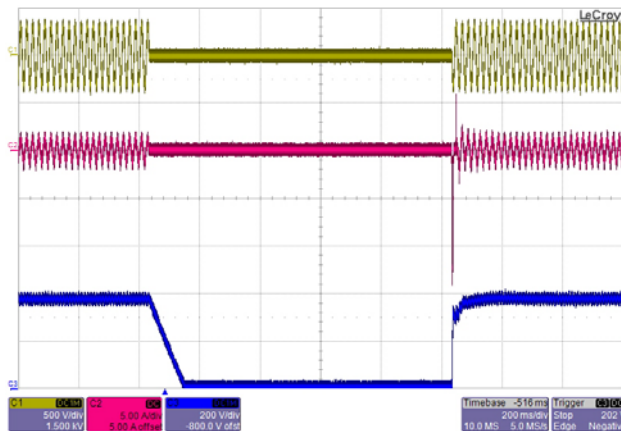

Figure 50 – Line Dropout 230 VAC, 1000 ms.
 Upper: V_{IN} , 500 V / div.
 Middle: I_{IN} , 5 A / div.
 Lower: V_{OUT} , 200 V, 200 ms / div.

16.13 One Cycle Line Dropout (115 VAC / 60 Hz and 230 VAC / 50 Hz)

16.13.1 Full Load at Output

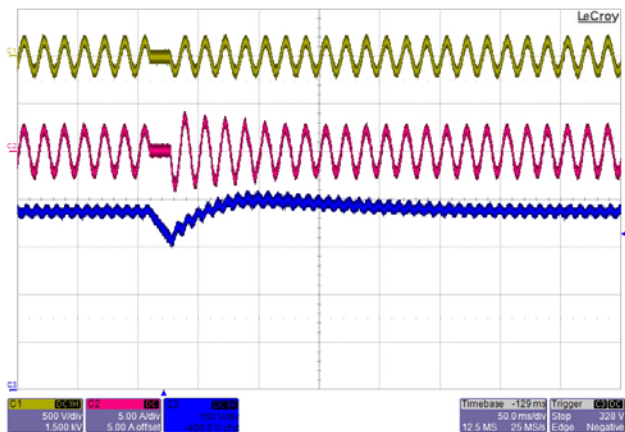

Figure 51 – Line Dropout 115 VAC, 60 Hz.
 Upper: V_{IN} , 500 V / div.
 Middle: I_{IN} , 5 A / div.
 Lower: V_{OUT} , 100 V / div., 50 ms / div.

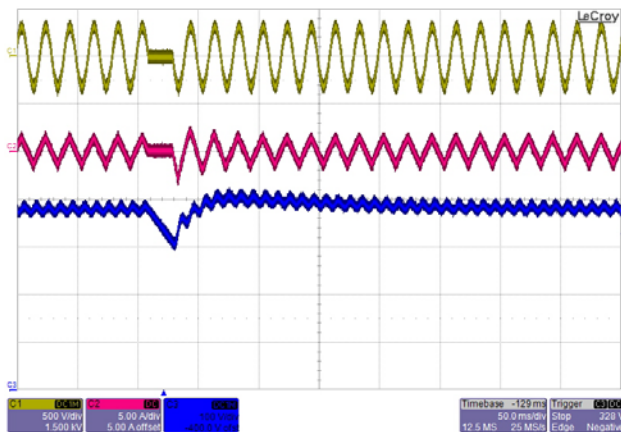

Figure 52 – Line Dropout 230 VAC, 50 Hz.
 Upper: V_{IN} , 500 V / div.
 Middle: I_{IN} , 5 A / div.
 Lower: V_{OUT} , 100 V / div., 50 ms / div.



16.14 Line Sag (115 VAC ~ 85 VAC ~ 115 VAC, 60 Hz)

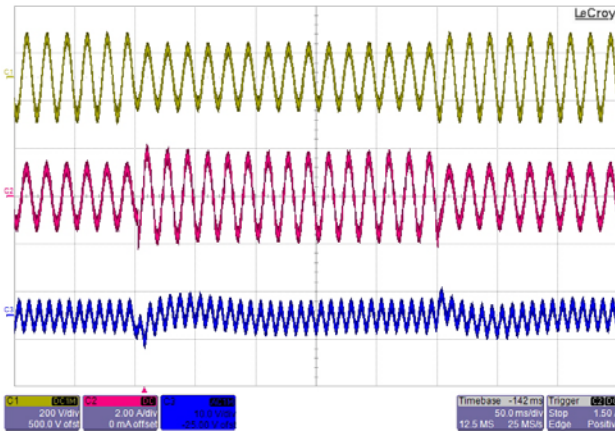

Figure 53 – Line Sag 115 VAC, 50% Load.
 Upper: V_{IN} , 200 V / div.
 Middle: I_{IN} , 2 A / div.
 Lower: V_{OUT} (AC Coupled), 10 V / div.,
 50 ms / div.

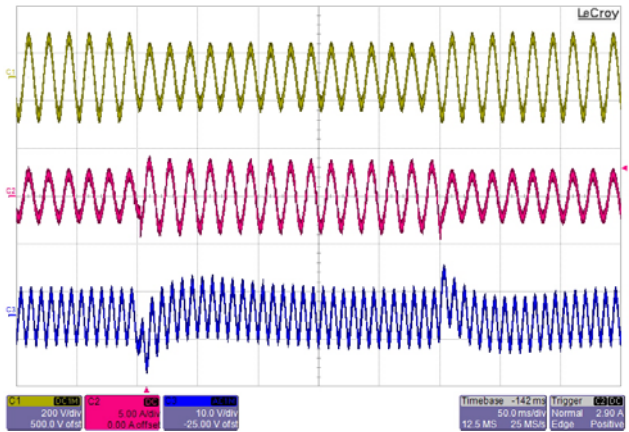

Figure 54 – Line Sag 115 VAC, 100% Load.
 Upper: V_{IN} , 200 V / div.
 Middle: I_{IN} , 5 A / div.
 Lower: V_{OUT} (AC Coupled), 10 V / div.,
 50 ms / div.

16.15 Line Surge (132 VAC ~ 147 VAC ~ 132 VAC, 60 Hz)

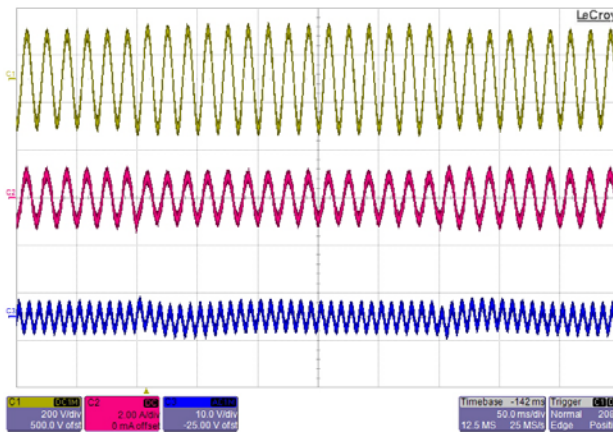

Figure 55 – Line Surge 132 VAC, 50% Load.
 Upper: V_{IN} , 200 V / div.
 Middle: I_{IN} , 2 A / div.
 Lower: V_{OUT} (AC Coupled), 10 V / div.

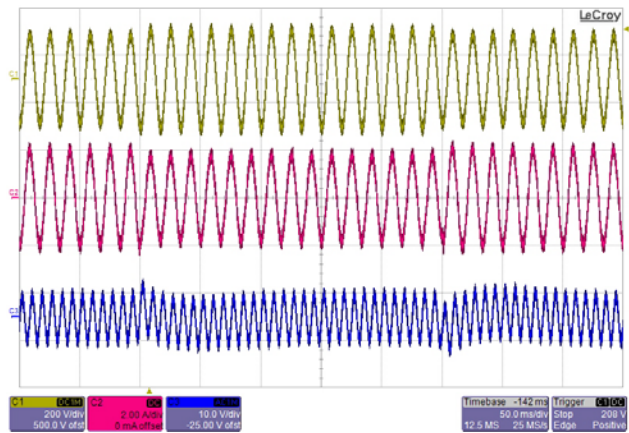

Figure 56 – Line Surge 132 VAC, 100% Load.
 Upper: V_{IN} , 200 V / div.
 Middle: I_{IN} , 2 A / div.
 Lower: V_{OUT} (AC Coupled), 10 V / div.



16.16 Line Sag (230 VAC ~ 170 VAC ~ 230 VAC, 50 Hz)

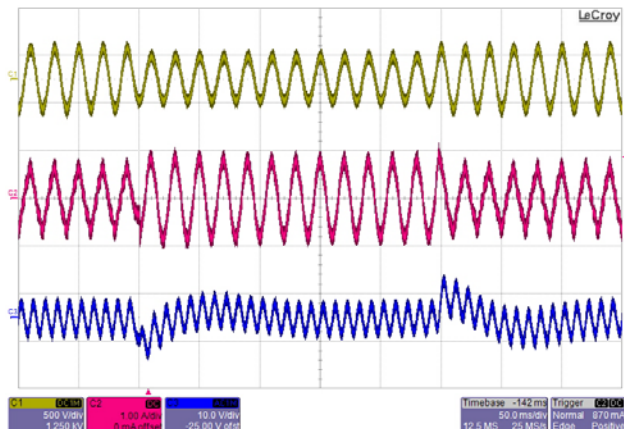

Figure 57 – Line Sag 230 VAC, 50% Load.
 Upper: V_{IN} , 500 V / div.
 Middle: I_{IN} , 1 A / div.
 Lower: V_{OUT} (AC Coupled), 10 V / div.

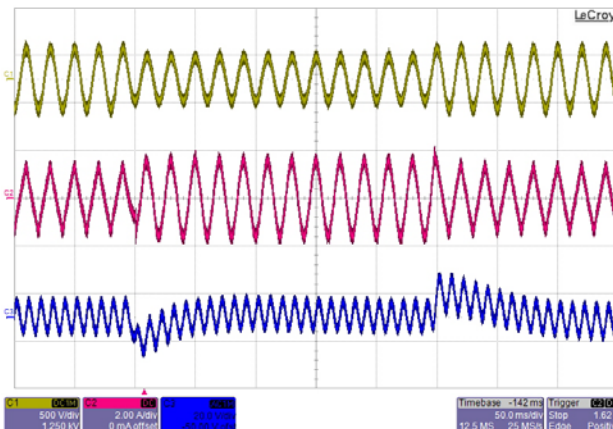

Figure 58 – Line Sag 230 VAC, 100% Load.
 Upper: V_{IN} , 500 V / div.
 Middle: I_{IN} , 2 A / div.
 Lower: V_{OUT} (AC Coupled), 20 V / div

16.17 Line Surge (264 VAC ~ 293 VAC ~ 264 VAC, 50 Hz)

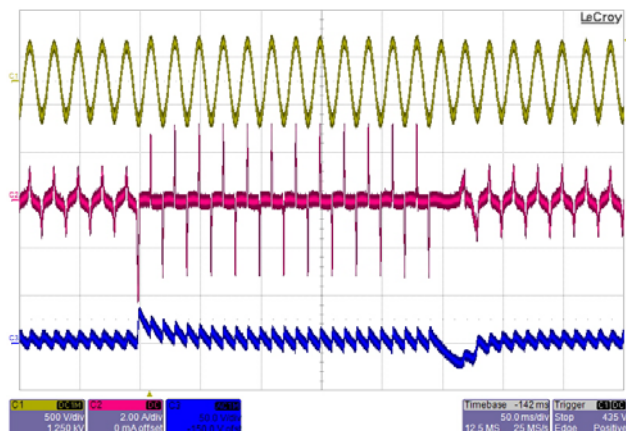

Figure 59 – Line Surge 264 VAC, 50% Load.
 Upper: V_{IN} , 500 V / div.
 Middle: I_{IN} , 2 A / div.
 Lower: V_{OUT} (AC Coupled), 50 V / div. ,
 50 ms / div.

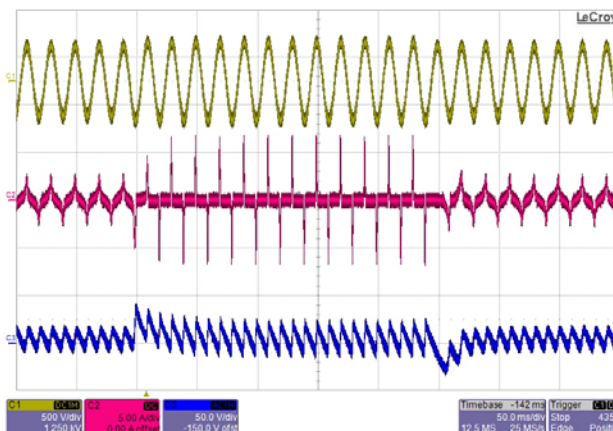

Figure 60 – Line Surge 264 VAC, 100% Load.
 Upper: V_{IN} , 500 V / div.
 Middle: I_{IN} , 5 A / div.
 Lower: V_{OUT} (AC Coupled), 50 V / div. ,
 50 ms / div.



16.18 Brown-In and Brown-Out at 6 V / Minute Rate

Test conducted by first reducing, followed by increasing input AC voltage source at a rate of 6 V / min. The PFC converter DC output was loaded to 100% of rated load (electronic load), which was programmed to release the load when the DC output of the PFC dropped below 300 V [at brown-out]. The auxiliary +15 V supply is connected to the output of the PFC and discharges the output capacitor of the PFC after the dynamic load is released at brown-out.

Measured PFC Brown-Out Threshold	70.8 VAC
Measured PFC Brown-In Threshold	80.6 VAC
Measured auxiliary Supply Brown-In Threshold	61.7 VAC

Note: Operation at low input voltages results in higher power dissipation in many components on the board. Forced air cooling is necessary during this test.

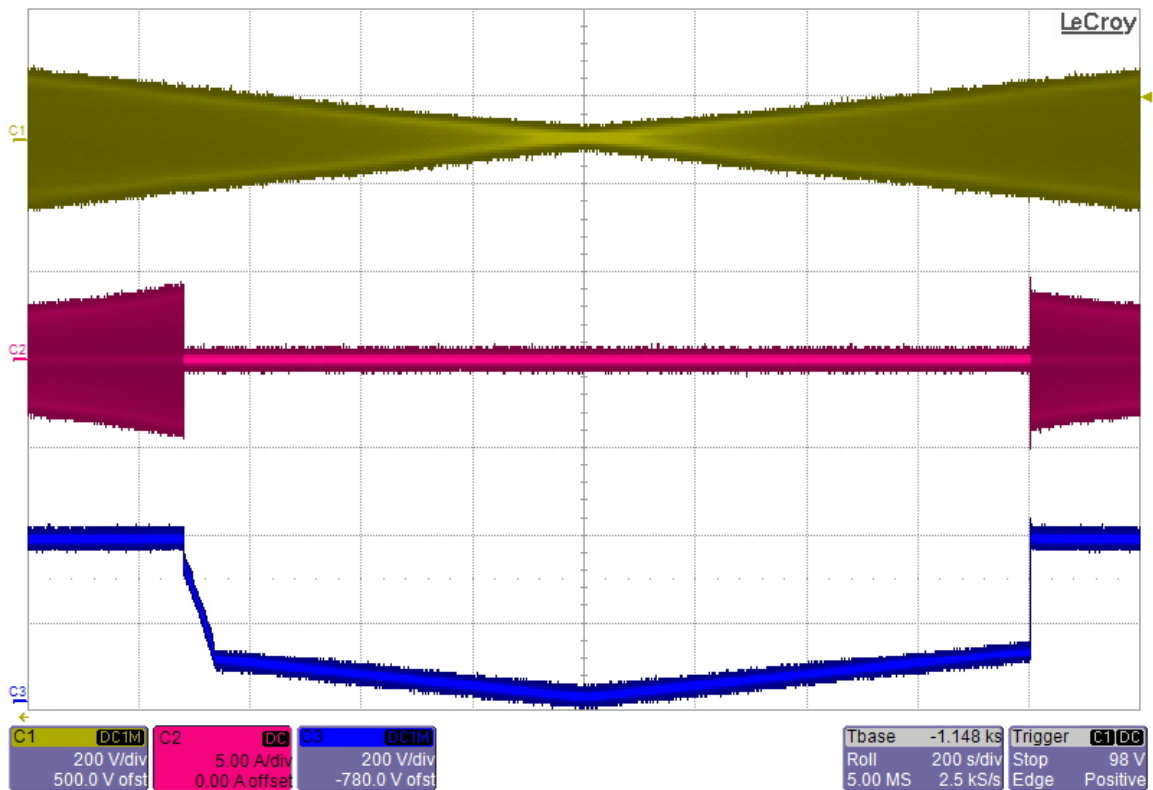

Figure 61 – Brown-Out Followed by Brown-In at 100% Load.

Top: V_{IN} , 200 V / div.

Middle: I_{IN} , 5 A / div.

Lower: V_{OUT} , 200 V / div., 200 s / div.

16.19 Drain Voltage and Current

The drain current was measured at jumper JP4 location by replacing JP4 with a very short wire loop in order to insert the current probe. The drain voltage was measured at the DRAIN and SOURCE pins of IC U1. Keep the wire loop as short as possible to minimize drain node inductance since the added inductance at the drain node can result in a high V_{DS} voltage that could damage U1. Drain current can be indirectly measured by measuring the switching inductor current during the MOSFET on-time. Refer to Appendix C for output inductor current measurement set-up and calculations.

16.19.1 Drain Voltage and Current at 115 VAC Input and Full Load

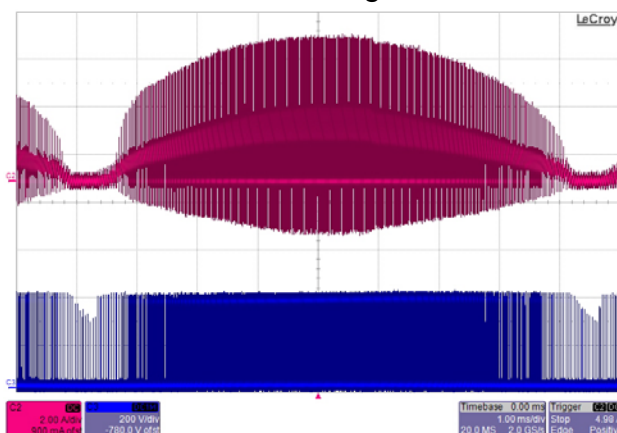

Figure 62 – Input Voltage 115 VAC, 100% Load.
Upper: I_{DRAIN} , 2 A / div.
Lower: V_{DRAIN} , 200 V / div., 1 ms / div.

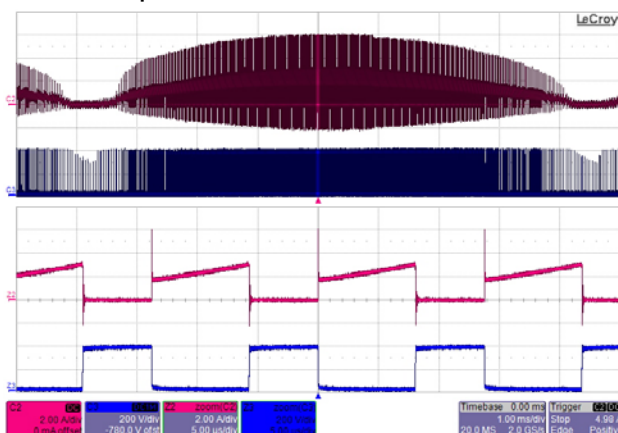

Figure 63 – Input Voltage 115 VAC, 100% Load.
Upper: I_{DRAIN} , 2 A / div.
Lower: V_{DRAIN} , 200 V / div., 1 ms / div.
Zoom Upper: I_{DRAIN} , 2 A / div.
Zoom Lower: V_{DRAIN} , 200 V / div., 5 μ s / div



16.19.2 Drain Voltage and Current at 230 VAC Input and Full Load

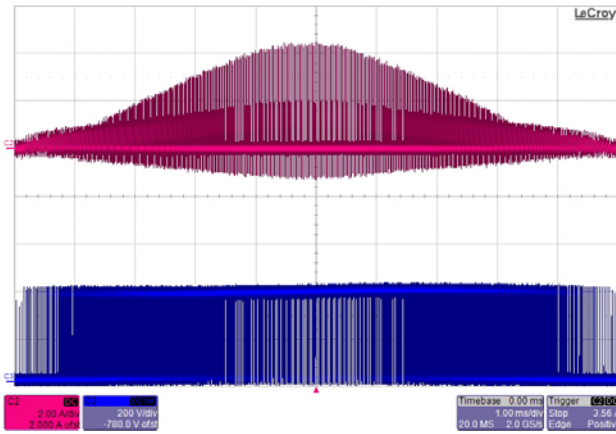

Figure 64 – Input Voltage 230 VAC, 100% Load.
 Upper: I_{DRAIN} , 2A / div.
 Lower: V_{DRAIN} , 200V / div., 1 ms / div.

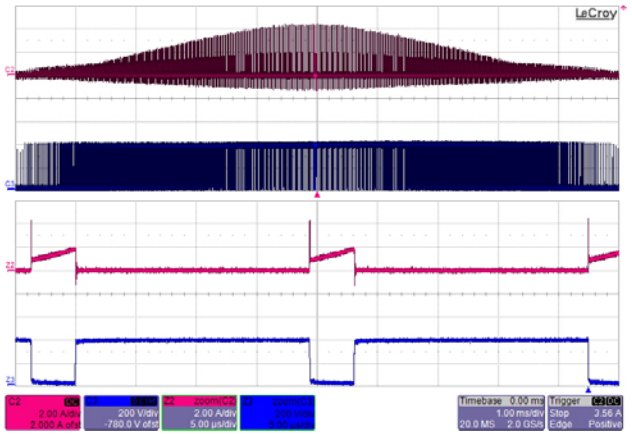

Figure 65 – Input Voltage 230 VAC, 100% Load.
 Upper: I_{DRAIN} , 2 A / div.
 Lower: V_{DRAIN} , 200 V / div., 1 ms / div.
 Zoom Upper: I_{DRAIN} , 2 A / div.,
 Zoom Lower: V_{DRAIN} , 200 V / div., 5 μ s / div.



16.20 Output Ripple Measurements

16.20.1 Ripple Measurement Technique

For DC output ripple measurements, a modified oscilloscope test probe must be utilized in order to reduce spurious signals due to pickup. Details of the probe modification are provided in the figures below.

The 4987BA probe adapter is affixed with one capacitor 0.02 μF /1 kV ceramic disc type tied in parallel across the probe tip.

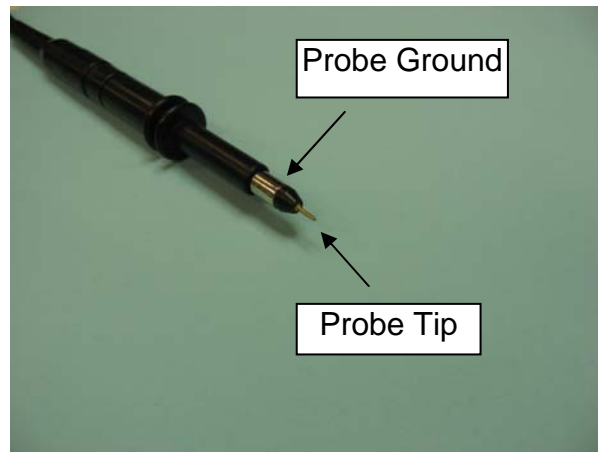

Figure 66 – Oscilloscope Probe Prepared for Ripple Measurement (End Cap and Ground Lead Removed).



Figure 67 – Oscilloscope Probe with Probe Master (www.probemaster.com) 4987A BNC Adapter (Modified with wires for ripple measurement, and one parallel decoupling capacitor added.)

16.20.2 Measurement Results

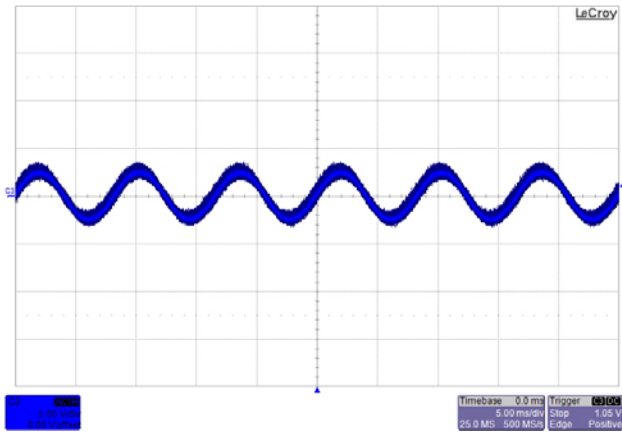

Figure 68 – Ripple, 90 VAC, 50% Load.
5 ms, 5 V / div.

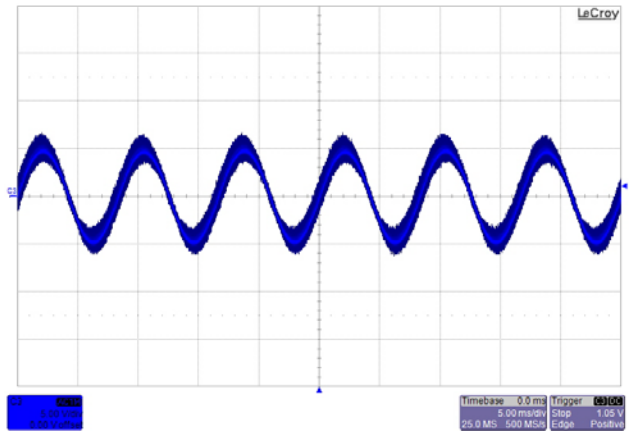

Figure 69 – Ripple, 90 VAC, 100% Load.
5 ms, 5 V / div.

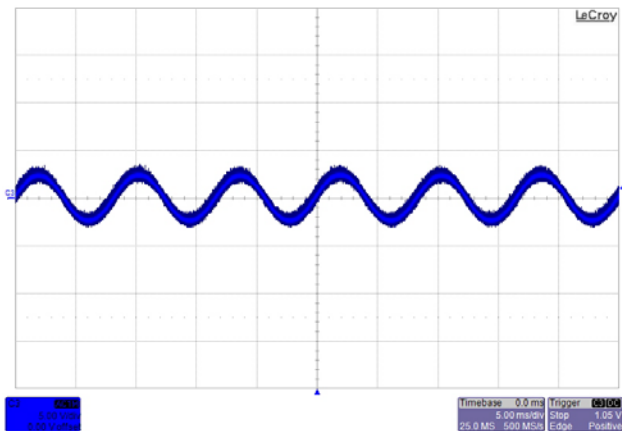

Figure 70 – Ripple, 115 VAC, 50% Load.
5 ms, 5 V / div.

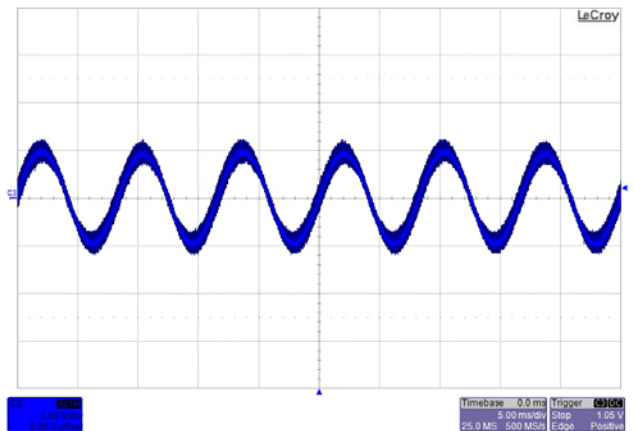

Figure 71 – Ripple, 115 VAC, 100% Load.
5 ms, 5 V / div.



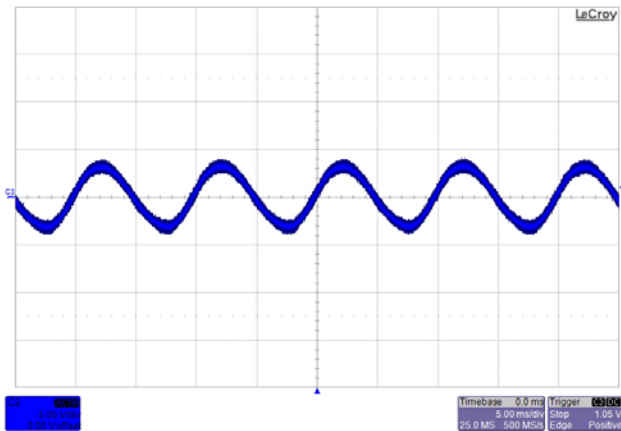

Figure 72 – Ripple, 230 VAC, 50% Load.
5 ms, 5 V / div.

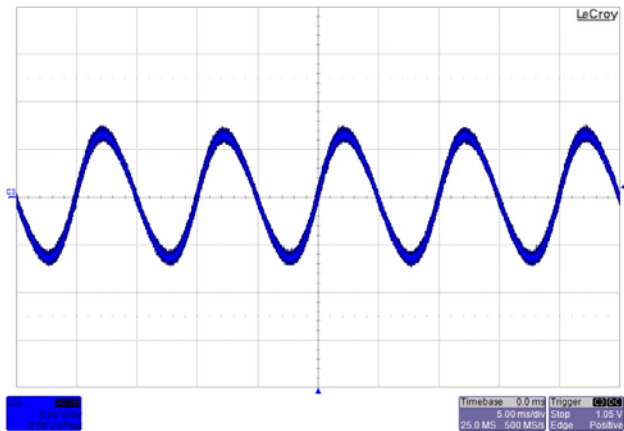

Figure 73 – Ripple, 230 VAC, 100% Load.
5 ms, 5 V / div.

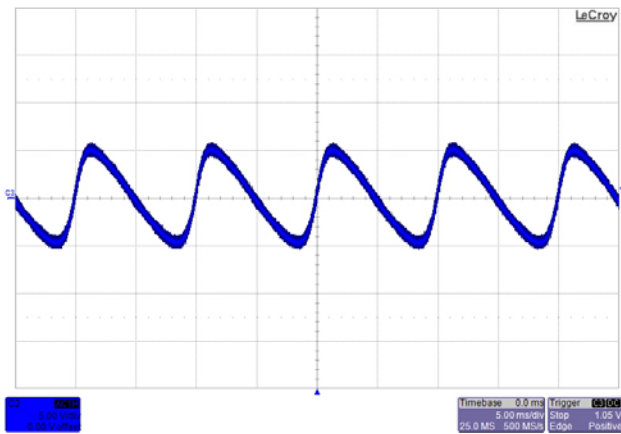

Figure 74 – Ripple, 264 VAC, 50% Load.
5 ms, 5 V / div.

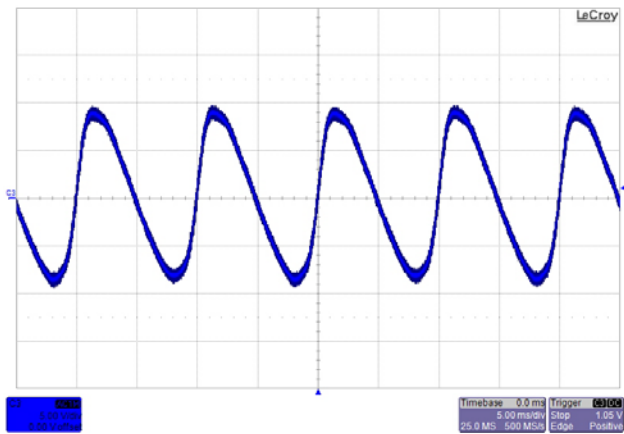

Figure 75 – Ripple, 264 VAC, 100% Load.
5 ms, 5 V / div.



17 Gain-Phase Measurement Procedure and Results

- The PFC stage is supplied from an adjustable DC source for this test. Connect the circuit as shown in Figure 76. Open the top end of the feedback divider network and insert a $100\ \Omega$, 2 W resistor in series as shown. The signal injected in the loop for gain phase measurement will be injected across this resistor.
- Nodes A and B (two ends of the injection resistor) are connected to Channel 1 and Channel 2 of the frequency response analyzer using high voltage $\times 100$ attenuator probes. GND leads of both probes are connected to output return as shown.
- The signal to be injected is isolated using the Bode-Box injection transformer model 200-000 from Venable Industries.

Test Procedure:

- Adjust the input voltage to 150 VDC and confirm that the PFC output voltage is within regulation limits.
- Inject a signal from the frequency response analyzer.
- The injected signal can be seen in the output voltage ripple of the PFC.
- Plot the gain phase plot by sweeping the injected signal frequency from 3 Hz to 90 Hz.

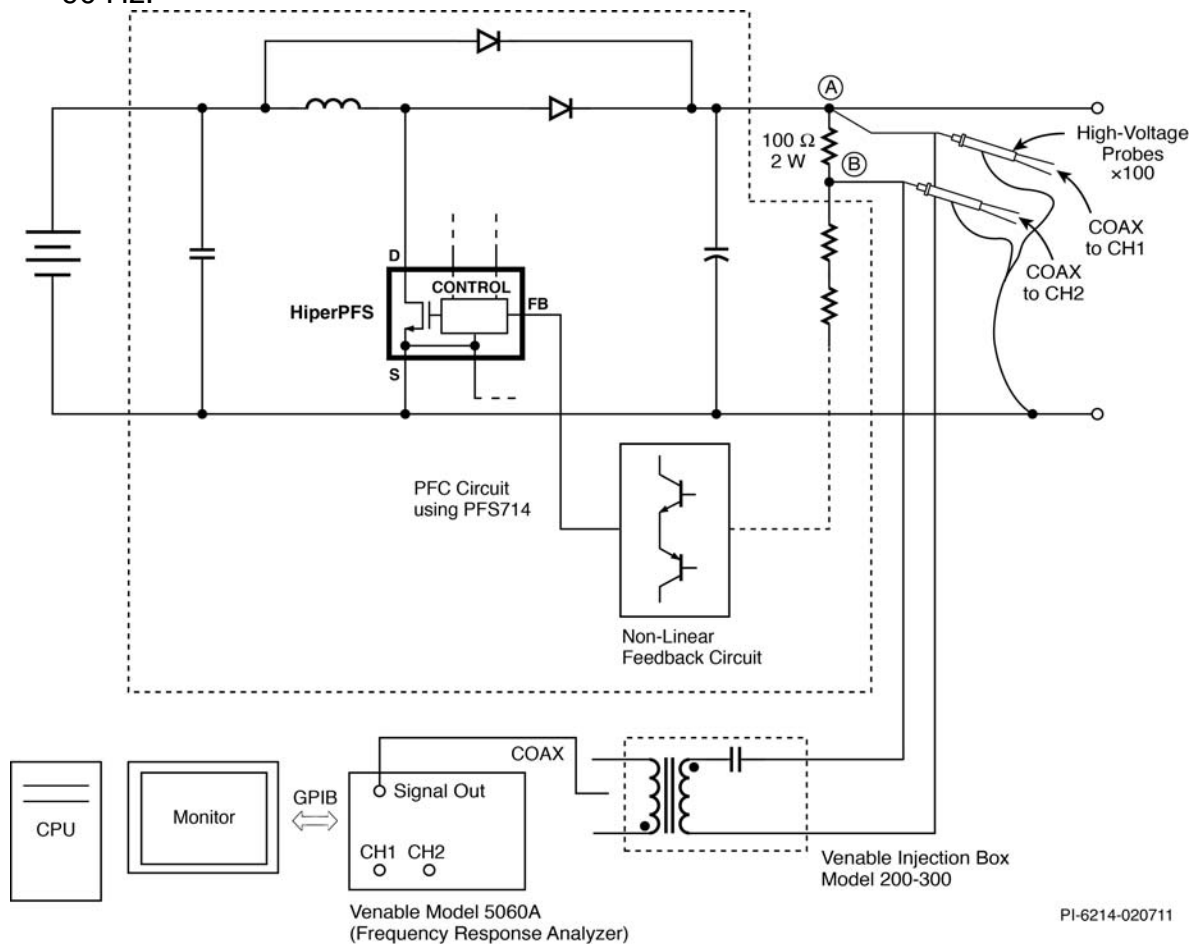

Figure 76 – System Test Set-up for Loop Gain-Phase Measurement.

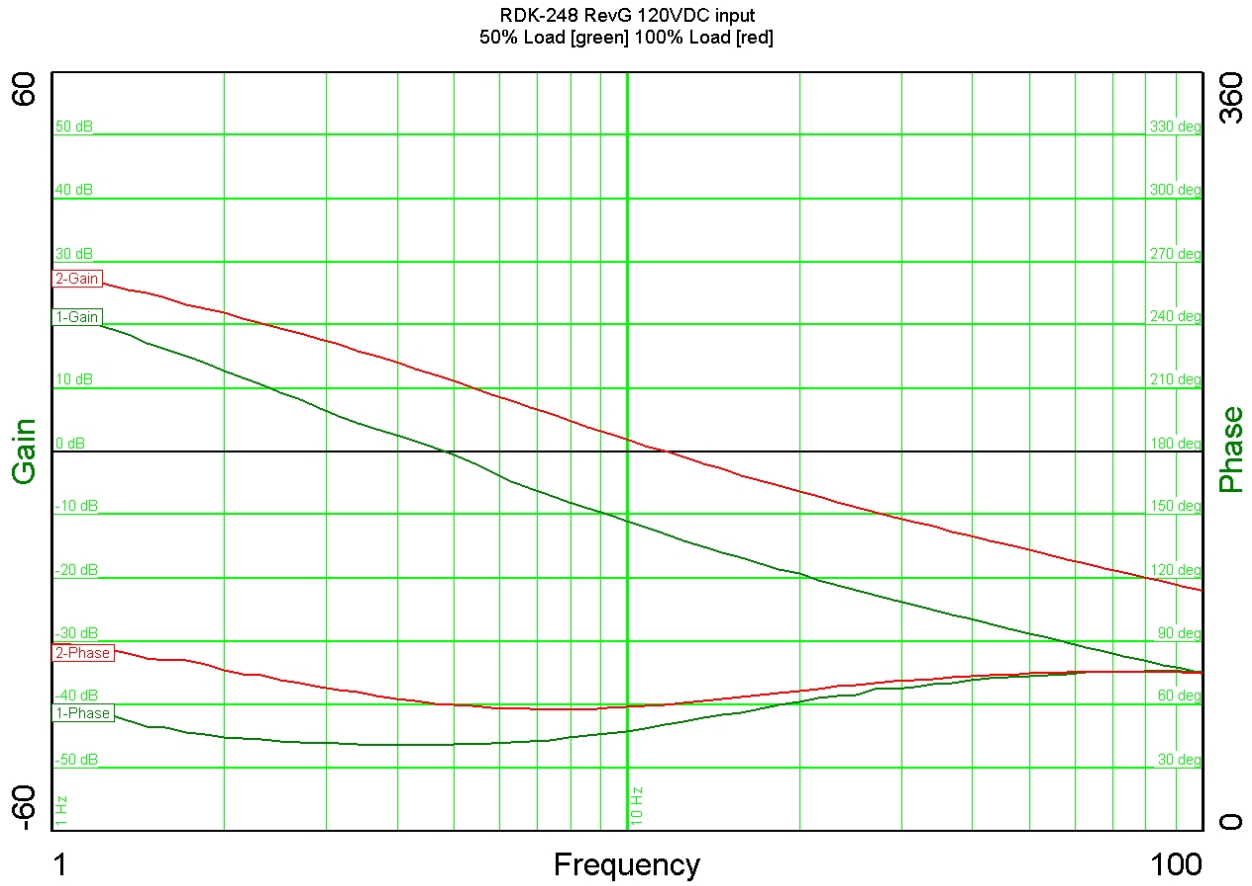

Figure 77 – Bode Plot with $V_{IN} = 120$ VDC at 100% Load (Red) and 50% Load (Green).



18 Line Surge Test

Surge Level (V)	Input Voltage (VAC)	Injection Location	Injection Phase (°)	Test Results (Pass / Fail, # Strikes)
C.M.		(12Ω source)		10 Strikes each Level
+500	230	L1 to PE	90	Pass
-500	230	L1 to PE	270	Pass
+500	230	L2 to PE	270	Pass
-500	230	L2 to PE	90	Pass
+500	230	L1, L2 to PE	90 ¹	Pass
-500	230	L1, L2 to PE	90	Pass
D.M.		(2Ω source)		
+500	230	L1 to L2	90 ²	Pass
-500	230	L1 to L2	270	Pass
C.M.		(12Ω source)		
+1000	230	L1 to PE	90	Pass
-1000	230	L1 to PE	270	Pass
+1000	230	L2 to PE	270	Pass
-1000	230	L2 to PE	90	Pass
+1000	230	L1, L2 to PE	90 ¹	Pass
-1000	230	L1, L2 to PE	90	Pass
D.M.		(2Ω source)		
+1000	230	L1 to L2	90 ²	Pass
-1000	230	L1 to L2	270	Pass
C.M.		(12Ω source)		
+1500	230	L1 to PE	90	Pass
-1500	230	L1 to PE	270	Pass
+1500	230	L2 to PE	270	Pass
-1500	230	L2 to PE	90	Pass
+1500	230	L1, L2 to PE	90 ¹	Pass
-1500	230	L1, L2 to PE	90	Pass
C.M.		(12Ω source)		
+2000	230	L1 to PE	90	Pass
-2000	230	L1 to PE	270	Pass
+2000	230	L2 to PE	270	Pass
-2000	230	L2 to PE	90	Pass
+2000	230	L1, L2 to PE	90 ¹	Pass
-2000	230	L1, L2 to PE	90	Pass

¹ Note: 0° and 270° phase angle [relative to L1] was not tested; however, negative voltage polarity was performed at 90° phase angle for worst case total negative pulse on alternate phase [neutral].

² Note: 0° and 270° phase angle [relative to L1] was not tested on both polarities; however, negative voltage polarity was performed at 270° phase angle for worst case total negative pulse on alternate phase [neutral].



19 EMI Scans

19.1 EMI Test Set-up

Using a plexi-glass board with the underside copper coated, electrically connect the copper side of the board to test point TP8 with a wire clip. The RD-248 assembly should be placed on top of the plexi-glass board. Connect output connector J2 to a high-voltage DC load. All interconnections should be made as short as possible. See Figure 78 for set-up.

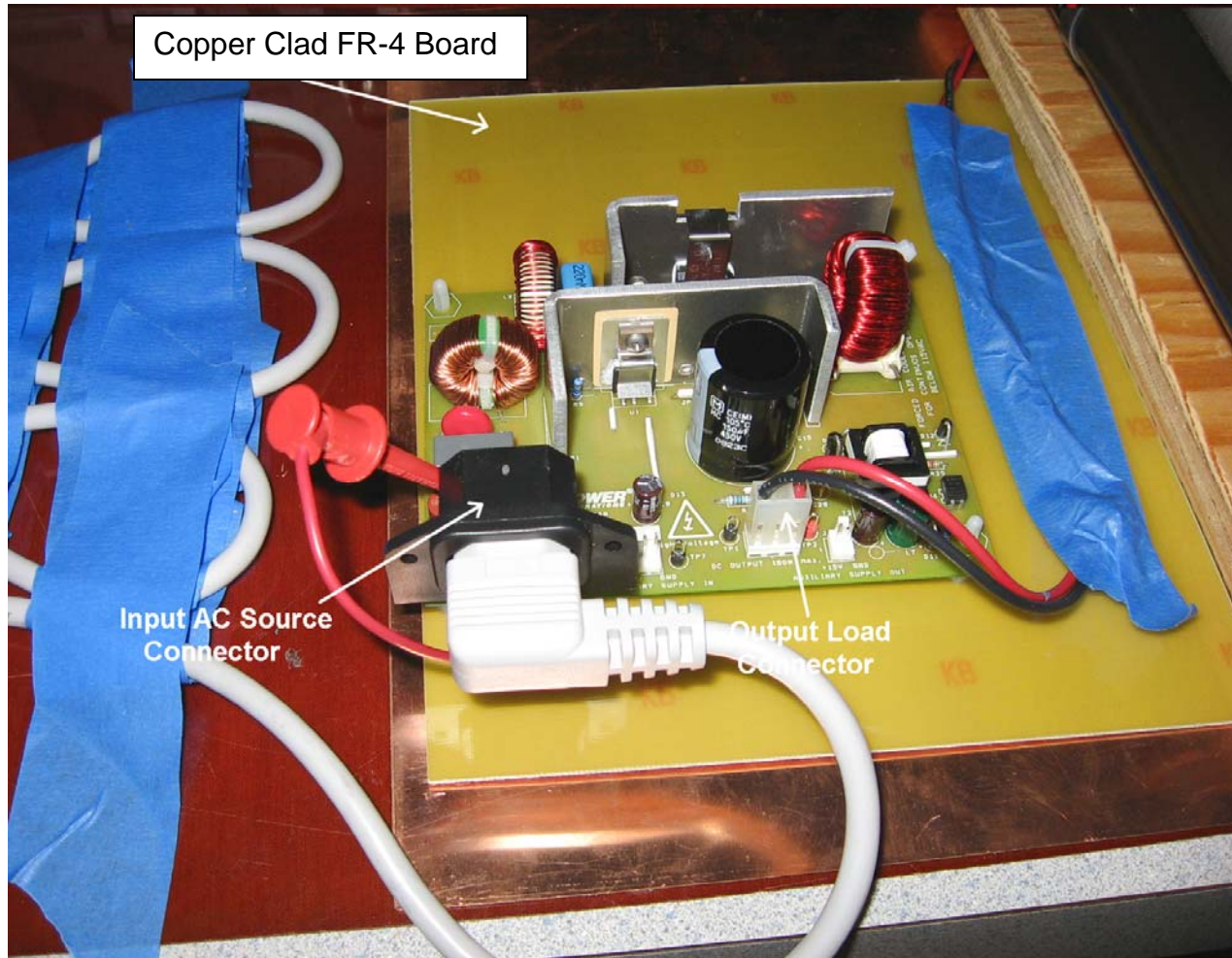

Figure 78 – EMI Test Set-up.



19.2 EMI Scans

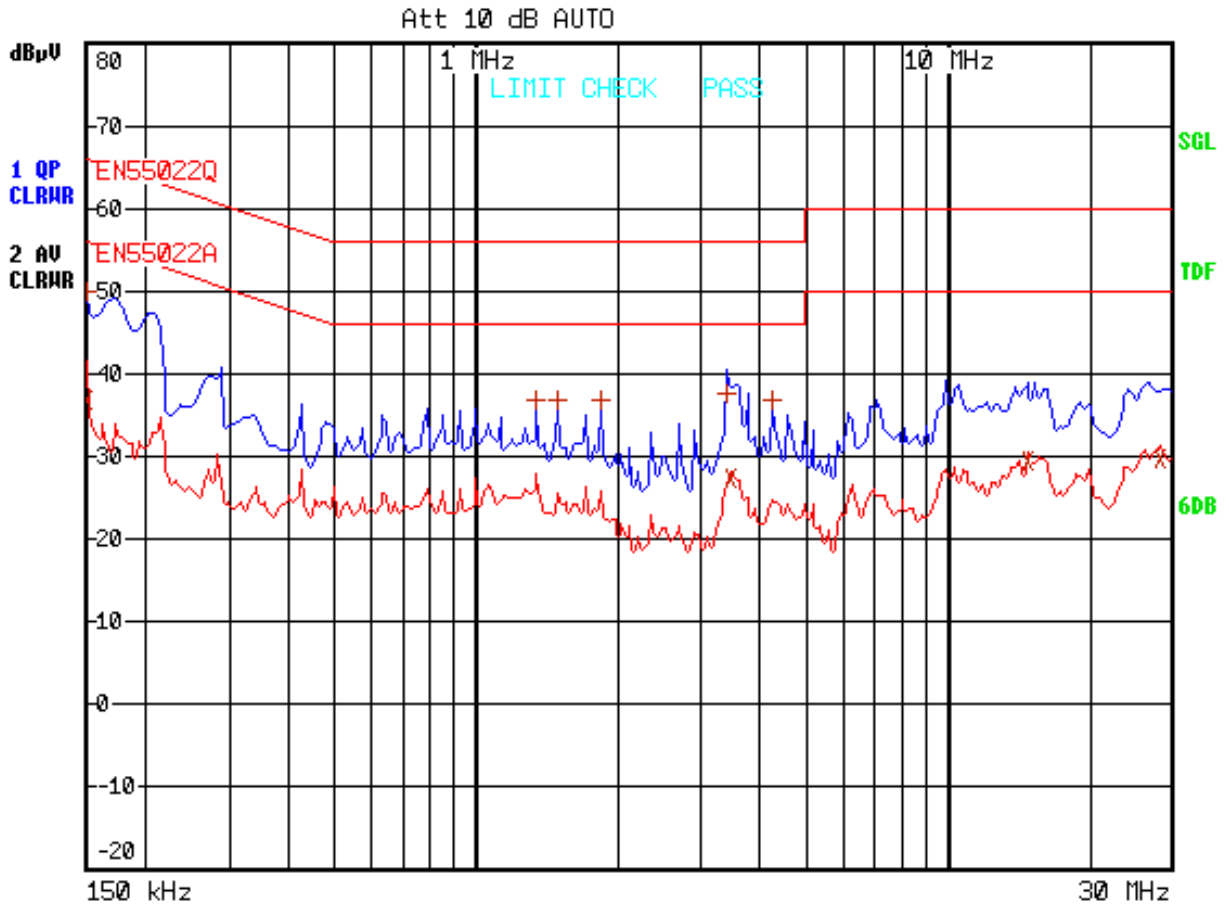

Figure 79 – 115 VAC, 100% Load.

EDIT PEAK LIST (Final Measurement Results)						
Trace1:	EN55022Q					
Trace2:	EN55022A					
Trace3:	---					
TRACE	FREQUENCY	LEVEL	dBµV		DELTA	LIMIT
1 Quasi Peak	150 kHz	50.06	N	gnd	-15.93	
2 Average	150 kHz	36.88	N	gnd	-19.11	
1 Quasi Peak	1.35117102853 MHz	36.82	L1	gnd	-19.17	
1 Quasi Peak	1.49180199444 MHz	36.95	L1	gnd	-19.04	
1 Quasi Peak	1.85486827309 MHz	36.75	L1	gnd	-19.24	
1 Quasi Peak	3.42703387612 MHz	37.68	L1	gnd	-18.31	
2 Average	3.49557455365 MHz	27.40	L1	gnd	-18.59	
1 Quasi Peak	4.26108587557 MHz	36.85	N	gnd	-19.14	
2 Average	14.8364879374 MHz	29.44	N	gnd	-20.55	
2 Average	28.5191630374 MHz	29.77	N	gnd	-20.22	

Figure 80 – 115 VAC, 100% Load EMI Measurement Results.



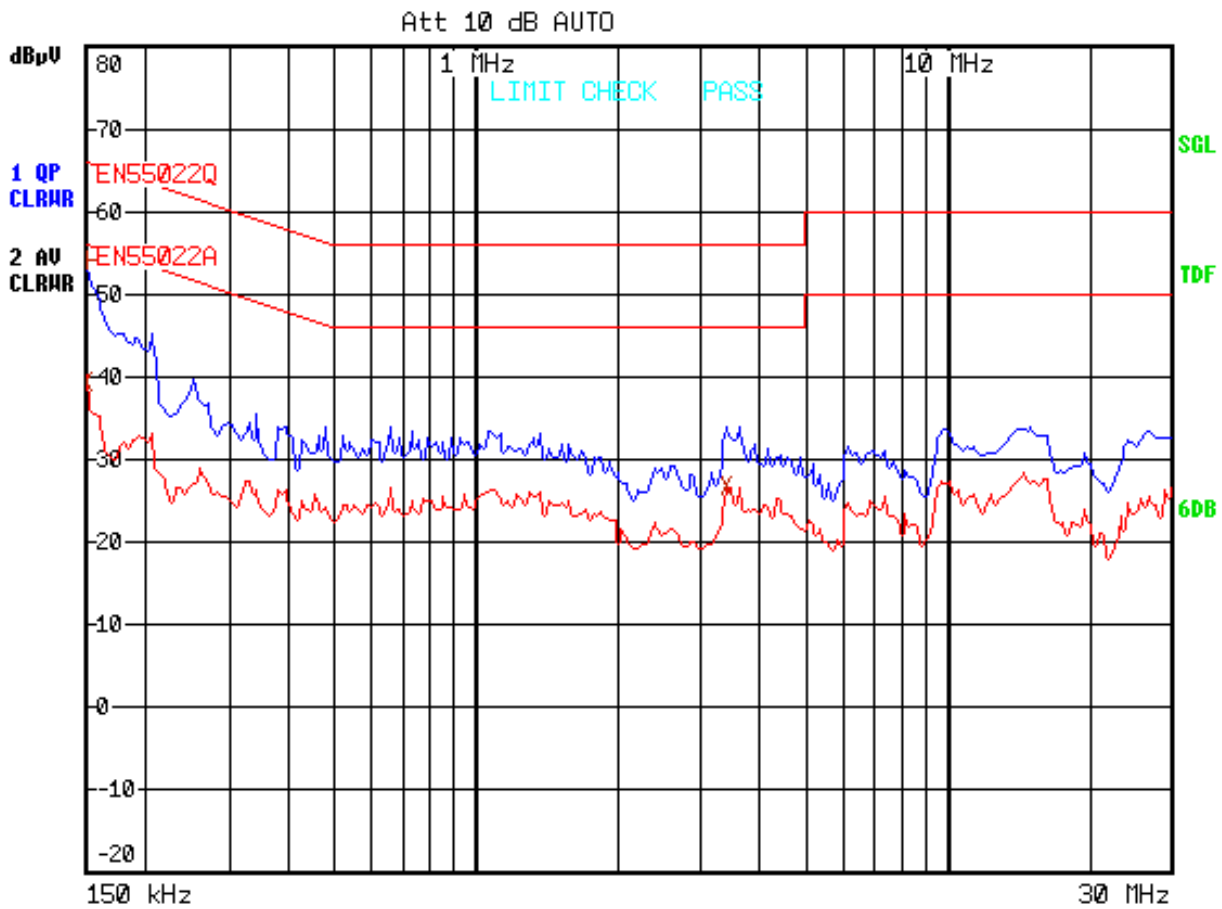

Figure 81 – 230 VAC, 100% Load.

EDIT PEAK LIST (Final Measurement Results)				
Trace1:	EN55022Q			
Trace2:	EN55022A			
Trace3:	---			
TRACE	FREQUENCY	LEVEL dBµV	DELTA LIMIT dB	
1 Quasi Peak	150 kHz	54.14 N gnd	-11.85	
2 Average	150 kHz	39.46 L1 gnd	-16.53	
2 Average	3.42703387612 MHz	26.88 L1 gnd	-19.11	

Figure 82 – 230 VAC, 100% Load EMI Measurement Results.



20 Appendix A - Test Set-up for Efficiency Measurement

The following setup is recommended for system efficiency, PF and THDi measurements. A 3" 12 VDC muffin fan is placed adjacent to the RD-248 board and powered by a 12 V supply for forced air cooling. Use of high resolution meters is recommended for output current and output voltage measurements. See Figure 83 for a typical equipment set-up.

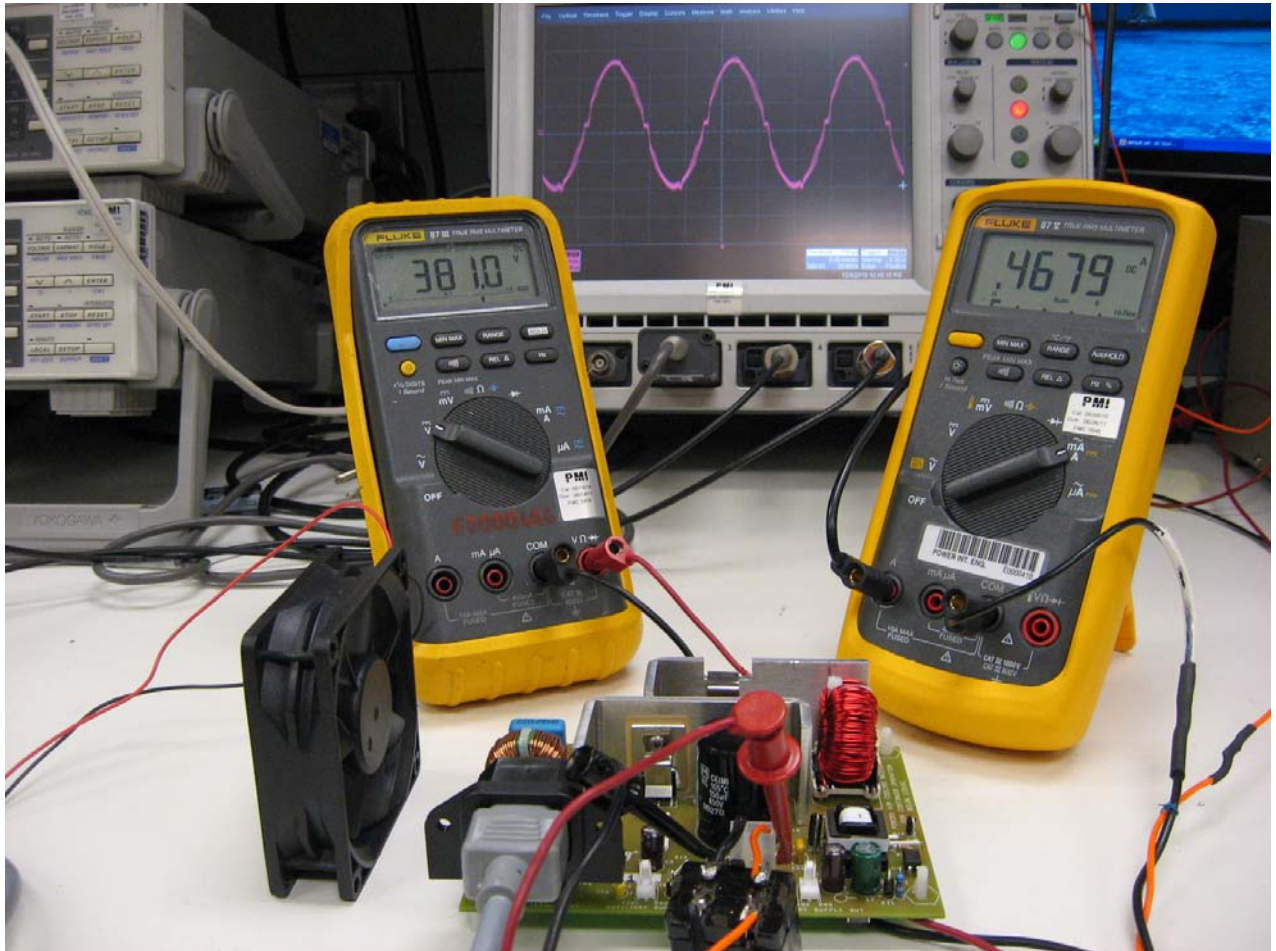

Figure 83 – Front View of the Test Set-up for Efficiency, PF and THDi Measurements.

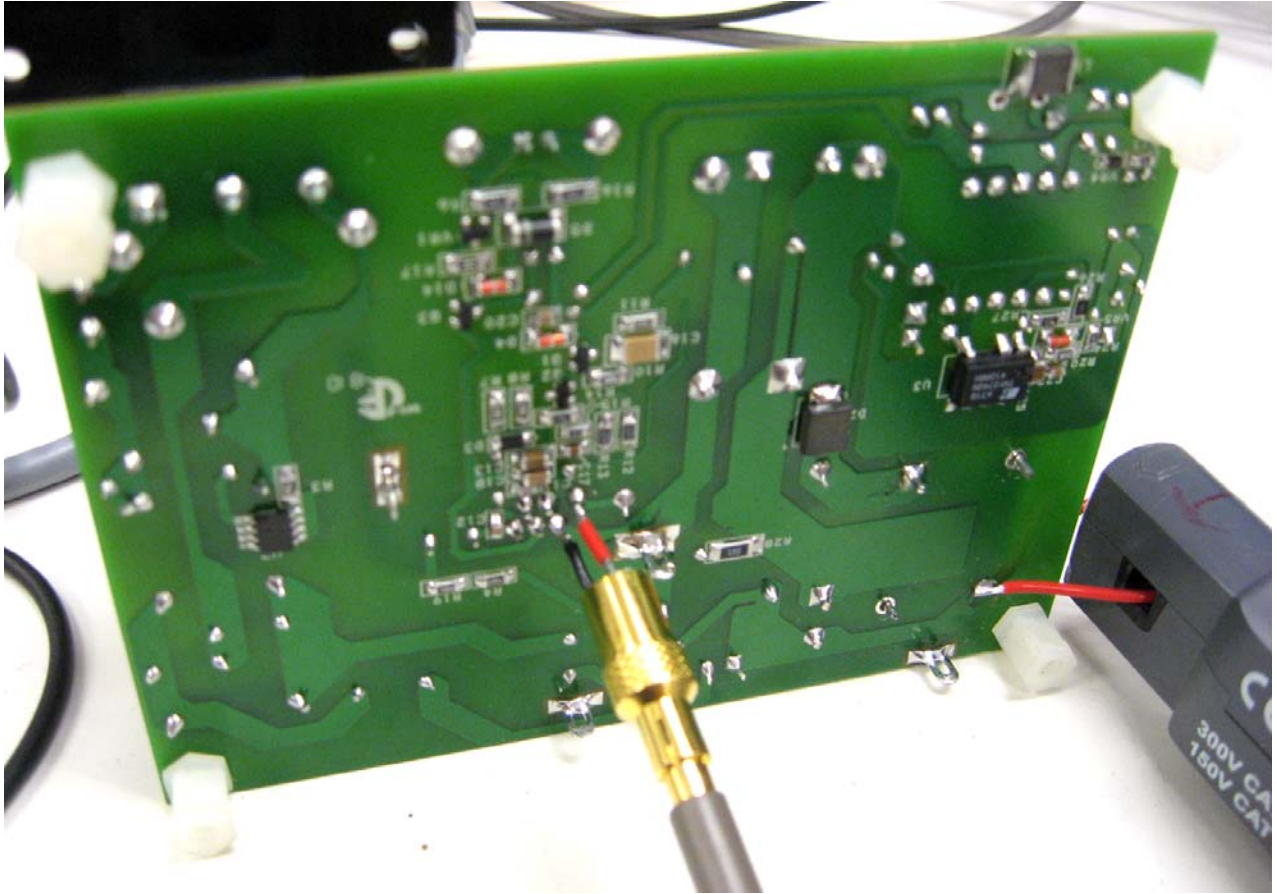

Figure 85 – Inductor Current and Drain Source Voltage Measurements Set-up.



22 Revision History

Date	Author	Revision	Description & changes	Reviewed
25-Mar-10	DCP	1.0	Initial Release	Apps & Mktg



For the latest updates, visit our website: www.powerint.com

Power Integrations reserves the right to make changes to its products at any time to improve reliability or manufacturability. Power Integrations does not assume any liability arising from the use of any device or circuit described herein. POWER INTEGRATIONS MAKES NO WARRANTY HEREIN AND SPECIFICALLY DISCLAIMS ALL WARRANTIES INCLUDING, WITHOUT LIMITATION, THE IMPLIED WARRANTIES OF MERCHANTABILITY, FITNESS FOR A PARTICULAR PURPOSE, AND NON-INFRINGEMENT OF THIRD PARTY RIGHTS.

PATENT INFORMATION

The products and applications illustrated herein (including transformer construction and circuits external to the products) may be covered by one or more U.S. and foreign patents, or potentially by pending U.S. and foreign patent applications assigned to Power Integrations. A complete list of Power Integrations' patents may be found at www.powerint.com. Power Integrations grants its customers a license under certain patent rights as set forth at <http://www.powerint.com/ip.htm>.

The PI Logo, TOPSwitch, TinySwitch, LinkSwitch, DPA-Switch, PeakSwitch, CAPZero, SENZero, LinkZero, HiperPFS, HiperTFS, Qspeed, EcoSmart, Clampless, E-Shield, Filterfuse, StackFET, PI Expert and PI FACTS are trademarks of Power Integrations, Inc. Other trademarks are property of their respective companies. ©Copyright 2011 Power Integrations, Inc.

Power Integrations Worldwide Sales Support Locations

WORLD HEADQUARTERS

5245 Hellyer Avenue
San Jose, CA 95138, USA.
Main: +1-408-414-9200
Customer Service:
Phone: +1-408-414-9665
Fax: +1-408-414-9765
e-mail:
usasales@powerint.com

GERMANY

Rueckertstrasse 3
D-80336, Munich
Germany
Phone: +49-89-5527-3911
Fax: +49-89-5527-3920
e-mail:
eurosales@powerint.com

JAPAN

Kosei Dai-3 Building
2-12-11, Shin-Yokohama,
Kohoku-ku, Yokohama-shi,
Kanagawa 222-0033
Japan
Phone: +81-45-471-1021
Fax: +81-45-471-3717
e-mail: japansales@powerint.com

TAIWAN

5F, No. 318, Nei Hu Rd., Sec. 1
Nei Hu District
Taipei 114, Taiwan R.O.C.
Phone: +886-2-2659-4570
Fax: +886-2-2659-4550
e-mail:
taiwansales@powerint.com

CHINA (SHANGHAI)

Rm 1601/1610, Tower 1
Kerry Everbright City
No. 218 Tianmu Road West
Shanghai, P.R.C. 200070
Phone: +86-021-6354-6323
Fax: +86-021-6354-6325
e-mail:
chinasales@powerint.com

INDIA

#1, 14th Main Road
Vasanthanagar
Bangalore-560052
India
Phone: +91-80-4113-8020
Fax: +91-80-4113-8023
e-mail:
indiasales@powerint.com

KOREA

RM 602, 6FL
Korea City Air Terminal B/D, 159-6
Samsung-Dong, Kangnam-Gu,
Seoul, 135-728
Korea
Phone: +82-2-2016-6610
Fax: +82-2-2016-6630
e-mail: koreasales@powerint.com

EUROPE HQ

1st Floor, St. James's House
East Street, Farnham
Surrey GU9 7TJ
United Kingdom
Phone: +44 (0) 1252-730-141
Fax: +44 (0) 1252-727-689
e-mail:
eurosales@powerint.com

CHINA (SHENZHEN)

Rm A, B & C 4th Floor, Block C,
Electronics Science and
Technology Building
2070 Shennan Zhong Road
Shenzhen, Guangdong,
P.R.C. 518031
Phone: +86-755-8379-3243
Fax: +86-755-8379-5828
e-mail:
chinasales@powerint.com

ITALY

Via De Amicis 2
20091 Bresso MI
Italy
Phone: +39-028-928-6000
Fax: +39-028-928-6009
e-mail:
eurosales@powerint.com

SINGAPORE

51 Newton Road,
#19-01/05 Goldhill Plaza
Singapore, 308900
Phone: +65-6358-2160
Fax: +65-6358-2015
e-mail:
singaporesales@powerint.com

APPLICATIONS HOTLINE

World Wide +1-408-414-9660

APPLICATIONS FAX

World Wide +1-408-414-9760

